

VTEKE®

HAZİRAN 2023 ÜRÜN FİYAT KATALOĞU



www.vteke.com.tr

HAKKIMIZDA

VTEKE Elektrik olarak endüstriyel elektrik malzemeleri üreticisi olup birçok farklı alanda ürünler imal etmekteyiz. 35 ülkeden fazla noktaya ihracat yapmakta, gerek yurt içi gerekse yurt dışında birçok prestijli projeye ürün tedariki sağlamaktayız.

Sürdürülebilir kalite prensiplerimizle ulusal ve uluslararası TSE, TUV, CE, ISO, EAC, SABER, Sanayi ve Teknoloji Bakanlığı, Ölçü Aletleri Ulusal Tip Onay Belgesi (Mühür), CMIM gibi belgeler başta olmak üzere birçok sertifikasyona sahibiz.

Her geçen gün genişlemekte olan ürün gamımızla başta akım trafoları, analog göstergeler, kaçak akım koruma cihazları, minyatür röleler, akü şarj aletleri, güç kaynakları, sigorta çeşitleri, daha fazlası ve güçlü stok yapımızla müşterilerimize hizmet sunmaktayız.

Yukarıda bahsi geçen ürünlerin yanında müşterilerimizin taleplerine özel ürünler üreterek kaliteyi ve hızlı çözümleri sağlama noktasında süreçlere katkı sağlamaktayız.

Dünyanın her yerinden gelebilecek taleplere yönelik gerek geniş ürün gamımızla gerekse teknik desteğimizle her zaman hizmet sağlamaktan mutluluk duyarız.

İÇİNDEKİLER

KAÇAK AKIM RÖLELERİ VE ÇEKİRDEK DENGESİ AKIM TRAFOLARI (TROİDAL).....	4
AKIM TRAFOLARI.....	7
RÖLE VE SOKETLER.....	17
SİLİNDİRİK SİGORTA YUVALARI VE BUŞONLARI.....	21
ANALOG ÖLÇÜ ALETLERİ.....	24
CAM SİGORTALAR.....	28
AKIM TRANSDÜSERİ.....	30
AKÜ ŞARJ ALETİ VE GÜÇ KAYNAKLARI.....	32
DİJİTAL ÖLÇÜ ALETLERİ.....	33
ZAMAN RÖLELERİ.....	37
KUMANDA RÖLELERİ.....	40
KORUMA RÖLELERİ.....	42
BUTON SERİSİ VE AKSESUARLARI.....	45
İŞ-GÜÇ ZAMAN SAATLERİ.....	51

KAÇAK AKIM RÖLELERİ VE ÇEKİRDEK DENGESİ AKIM TRAFOLARI (TROIĐAL)

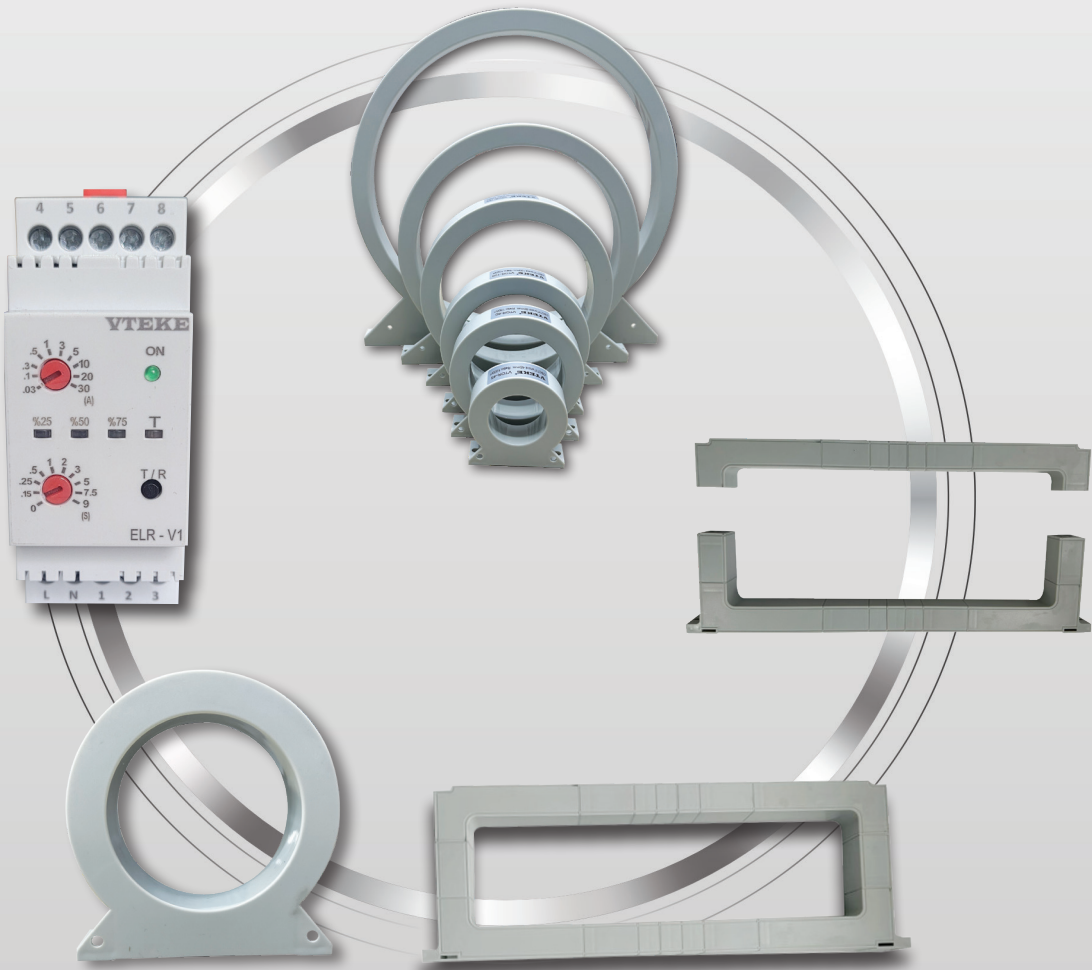

VTEKE®

KAÇAK AKIM RÖLESİ

ELR-V1

TEKNİK ÖZELLİKLER

PARAMETRE	DEĞER
Standartlar	IEC 60947-2 / IEC 60947-2 LV directive 2014/35/EU EMC directive 2014/30/EU
Besleme Voltajı	50-270 VAC/DC
Frekans	50/60 Hz
Çalışma Gücü	2VA
Çekirdek Denge Akım Trafosu Tipi	Sadece VTEKE V-XXX Serileri kullanılabilir
Kaçak Akım Rölesi Tipi	A Tipi
Kaçak Akım Trip Seviyesi	30mA, 100mA, 300mA, 500mA 1A, 3A, 5A, 10A, 20A, 30A
Gecikme zamanı	0 (<40 msec), 0.15, 0.25, 0.50 1, 2, 3, 5, 7, 9 sec
Reset zamanı	1 sec
Toroid Trafo fonksiyonu	Toroid Trafo kısa devre veya mevcut değil
Doğruluk	Ayarlanan Trip Akım +- %5 Ayarlanan Gecikme Zaman +- %5 + 0 (<40 msn)
Test/Reset İmkanı	Ön taraf (Buton) Uzaktan Terminal kontakları ile
Reset Limit Seviyesi	Çekirdek denge akım trafosu çıkış akımı ayarlanan trip akım seviyesinin %90'una düşüğünde reset fonksiyonu aktif olur
Trip Röle	1 NO +1 NC (Kontakt kapasitesi 10A)
Sıcaklık	Çalışma -10C to +70C Depolama -25C to +70C
Çalışma Yüksekliği	2000m
Montaj	DIN Ray 35mm
Terminals	Vidalı klemens. Kablo kesiti AWG30 ve AWG12 ile arası (0.06 mm ² 'den 3.3mm ² 'a kadar) standart veya sert
Kasa materyeli	ABS
Ağırlık	115 gr
Ebatlar	30x90x58

ÖZELLİKLER

Kaçak akım rölesi (ELR-V1), yük ve hatlar kaçak akıma karşı korumak için modüler tipte tasarlanmıştır. ELR-V1, ayarlanabilir gecikme zamanı ve ayarlanabilir kaçak akım esigi (trip akımı) sayesinde topraklama ve yalıtım hatalarını önlemek için ihtiyaç duyulan çeşitli uygulamalarda kullanılabilir.

- Kompakt Kasa
- 30mA to 30A aralığında ayarlanabilir kaçak akım eşığı
- 0 - 9 saniye aralığında ayarlanabilir gecikme zamanı
- 1 faz (Faz, Nötr), 3 faz (3 Faz veya 3 Faz + Nötr) sistemler ile uyumlu
- Belirlenen kaçak akım eşığına göre kaçak akım seviyesinin %25, %50, %75 ve %100 (Trip akımı) ledler ile gösterilmesi
- Cihaz ön paneli üzerinden test/reset butonu ile veya cihaz terminal bağlantısı kullanılarak uzaktan test/reset imkanı
- Cihaz girişinde CBCT bağlı olmadığı ve kısa devre olduğunda uyan verilmesi



BAĞLANTI ŞEMASI

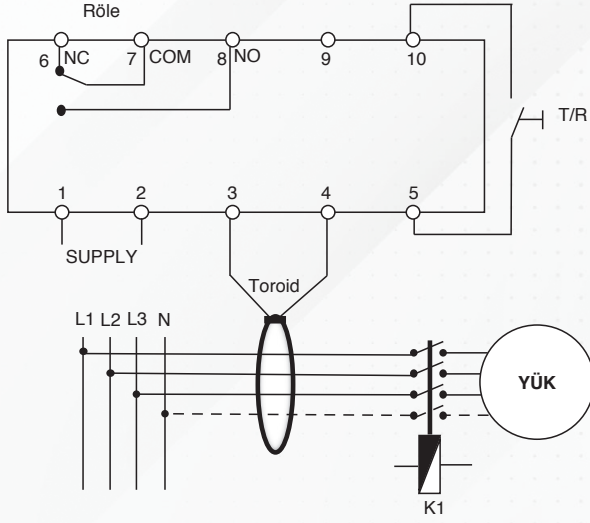

LED GÖSTERME DURUMU

DURUM	ON	25%	50%	75%	TRIP
Cihaz ON	ON	OFF	OFF	OFF	OFF
Trip Akımı Aşılış	ON	ON	ON	ON	ON
CBCT mevcut değil / kısa devre	ON	BLINK	BLINK	BLINK	BLINK
%25 Kaçak Akımı	ON	ON	OFF	OFF	OFF
%50 Kaçak Akımı	ON	ON	ON	OFF	OFF
%70 Kaçak Akımı	ON	ON	ON	ON	OFF

TOROID AKIM TRAFOSU

VTOR SERİSİ

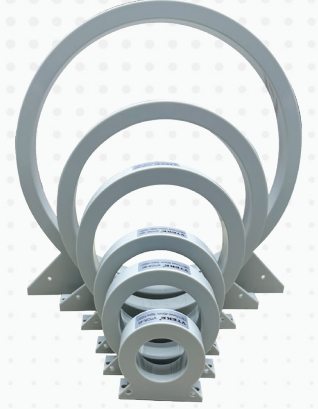

ÖZELLİKLER

- VTOR Serisi toroid akım trafolar pano içi kullanımlara uygundur.
- Epoksi reçine ile kaplanmış olup bu özellikleri ile sayesinde yüksek hassasiyet ve stabil çalışmaya sahiptir.
- 45mm - 500 mm aralığında çeşitli delik çaplarına sahiptir.

TEKNİK ÖZELLİKLER

PARAMETRE	DEĞER
Giriş Voltajı	100-240VAC/DC
Frekans	50/60 Hz
Doğruluk Sınıfı	1000/1
Accuracy Class	0.5
Test Voltajı	3kV AC, 1min
İzolasyon Direnci	DC500V/100MΩ
Çalışma Sıcaklığı	-15C to +45C

FİYAT LİSTESİ

KAÇAK AKIM RÖLESİ VE TORIOD		
ELR-V1	KAÇAK AKIM RÖLESİ 30mA - 30A	\$87,00
VTOR-45	TOROIDAL AKIM TRAFOSU 45MM	\$22,00
VTOR-80	TOROIDAL AKIM TRAFOSU 80MM	\$34,00
VTOR-100	TOROIDAL AKIM TRAFOSU 100MM	\$52,00
VTOR-150	TOROIDAL AKIM TRAFOSU 150MM	\$98,00
VTOR-210	TOROIDAL AKIM TRAFOSU 210MM	\$120,00
VTOR-310	TOROIDAL AKIM TRAFOSU 310MM	\$270,00
VDIK-36	Dikdörtgen CBCT 360X10	\$700,00
VDIK-50	Dikdörtgen CBCT 500X10	\$1.000,00
VAYR-36	Ayrılabilir Dikdörtgen CBCT 360X10	\$800,00
VAYR-50	Ayrılabilir Dikdörtgen CBCT 500X10	\$1.100,00

VDIK SERİSİ

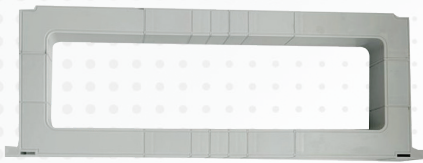

VAYR SERİSİ



AKIM TRAFOLARI



VTEKE®

XX-XXX-XXXX-X-X-XX

AKIM TRAFOSU KODLAMA ÇİZELGESİ

SERİ KODU	DELİK ÇAPI	PRİMER (A)	SEKONDER (A)	CLASS		VA DEĞERİ	
				KOD	CLASS	KOD	VA DEĞERİ
CK	20	5	1	1	01	1	
TK	30S	-	5	2	0.5	02	1.5
DK	30	-		3	0.5S	03	2.5
BK	40	-		4	0.1	04	3.75
BK1C	60	-		5	0.1S	05	5
SK	80	6300		6	0.2	06	7.5
MSK	100			7	0.2S	07	10
RK	120			8	5	08	12.5
	125			9	3	09	15
						10	20
						11	25
						12	30
						13	40
						14	50
						15	60

Örnek Kodlama: TK30 500/5A, CL.1.0, 7.5VA
 Örnek Kod: TK305005106

MONTAJ OPSİYONLARI

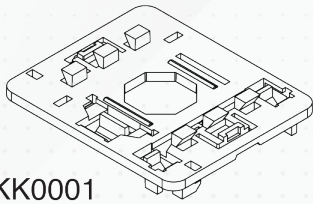

KK0001

DIN Ray Tipi Sabitleme Klipsi

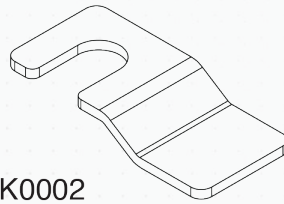

KK0002

Metal Sabitleyici

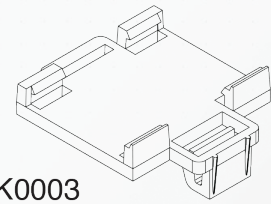

KK0003

DIN Ray Tipi Sabitleme Klipsi

FİYAT LİSTESİ
AKIM TRAFOLARI
DELİKLİ TİP AKIM TRAFOSU

CK20405901	AKIM TRAFOSU 40/5A, 20MM, SINIF 3, 1VA	\$10,00
CK20505901	AKIM TRAFOSU 50/5A, 20MM, SINIF 3, 1VA	\$10,00
CK20605101	AKIM TRAFOSU 60/5A, 20MM, SINIF 1, 1VA	\$10,00
CK20755102	AKIM TRAFOSU 75/5A, 20MM, SINIF 1, 1.5VA	\$10,00
CK20805102	AKIM TRAFOSU 80/5A, 20MM, SINIF 1, 1.5VA	\$10,00
CK201005102	AKIM TRAFOSU 100/5A, 20MM, SINIF 1, 1.5VA	\$10,00
CK201255103	AKIM TRAFOSU 125/5A, 20MM, SINIF 1, 2.5VA	\$10,00
CK201505103	AKIM TRAFOSU 150/5A, 20MM, SINIF 1, 2.5VA	\$10,00
CK201605103	AKIM TRAFOSU 160/5A, 20MM, SINIF 1, 2.5VA	\$10,00
CK202005103	AKIM TRAFOSU 200/5A, 20MM, SINIF 1, 2.5VA	\$10,00
CK202505103	AKIM TRAFOSU 250/5A, 20MM, SINIF 1, 2.5VA	\$10,00
CK203005103	AKIM TRAFOSU 300/5A, 20MM, SINIF 1, 2.5VA	\$10,00
CK201005202	AKIM TRAFOSU 100/5A, 20MM, SINIF 0.5, 1.5VA	\$10,50
CK201255202	AKIM TRAFOSU 125/5A, 20MM, SINIF 0.5, 1.5VA	\$10,50
CK201505202	AKIM TRAFOSU 150/5A, 20MM, SINIF 0.5, 1.5VA	\$10,50
CK201605202	AKIM TRAFOSU 160/5A, 20MM, SINIF 0.5, 1.5VA	\$10,50
TK30N605902	AKIM TRAFOSU 60/5A, 30MM, SINIF 3, 1.5VA	\$10,50
TK30N755902	AKIM TRAFOSU 75/5A, 30MM, SINIF 3, 1.5VA	\$10,50
TK30N805902	AKIM TRAFOSU 80/5A, 30MM, SINIF 1, 1.5VA	\$10,50
TK30N1005102	AKIM TRAFOSU 100/5A, 30MM, SINIF 1, 1.5VA	\$10,50
TK30N1255102	AKIM TRAFOSU 125/5A, 30MM, SINIF 1, 1.5VA	\$10,50
TK30N1505103	AKIM TRAFOSU 150/5A, 30MM, SINIF 1, 2.5VA	\$10,50
TK30N1605103	AKIM TRAFOSU 160/5A, 30MM, SINIF 1, 2.5VA	\$10,50
TK30N2005103	AKIM TRAFOSU 200/5A, 30MM, SINIF 1, 2.5VA	\$10,50
TK30N2505103	AKIM TRAFOSU 250/5A, 30MM, SINIF 1, 2.5VA	\$10,50
TK30N3005103	AKIM TRAFOSU 300/5A, 30MM, SINIF 1, 2.5VA	\$10,50
TK30N4005103	AKIM TRAFOSU 400/5A, 30MM, SINIF 1, 2.5VA	\$10,50
TK30N5005103	AKIM TRAFOSU 500/5A, 30MM, SINIF 1, 2.5VA	\$10,50
TK30N6005103	AKIM TRAFOSU 600/5A, 30MM, SINIF 1, 2.5VA	\$10,50
TK30N1505203	AKIM TRAFOSU 150/5A, 30MM, SINIF 0.5, 2.5VA	\$11,00
TK30N1605203	AKIM TRAFOSU 160/5A, 30MM, SINIF 0.5, 2.5VA	\$11,00
TK30N2005203	AKIM TRAFOSU 200/5A, 30MM, SINIF 0.5, 2.5VA	\$11,00
TK30N2505203	AKIM TRAFOSU 250/5A, 30MM, SINIF 0.5, 2.5VA	\$11,00
TK30N3005203	AKIM TRAFOSU 300/5A, 30MM, SINIF 0.5, 2.5VA	\$11,00
TK30N4005203	AKIM TRAFOSU 400/5A, 30MM, SINIF 0.5, 2.5VA	\$11,00
TK30N5005203	AKIM TRAFOSU 500/5A, 30MM, SINIF 0.5, 2.5VA	\$11,00
TK30N6005203	AKIM TRAFOSU 600/5A, 30MM, SINIF 0.5, 2.5VA	\$11,00

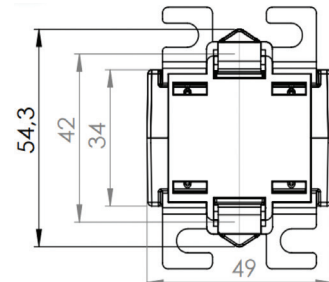
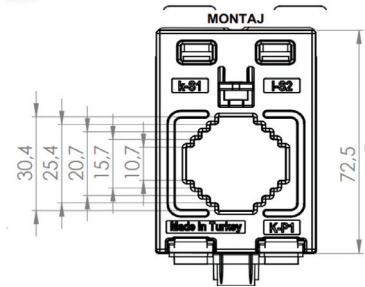
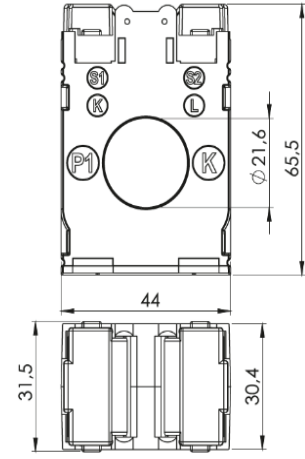

FİYAT LİSTESİ
DELİKLİ TİP AKIM TRAFOSU

TK30405901	AKIM TRAFOSU 40/5A, 30MM, SINIF 3, 1VA	\$12,86
TK30505101	AKIM TRAFOSU 50/5A, 30MM, SINIF 1, 1VA	\$16,00
TK30605101	AKIM TRAFOSU 60/5A, 30MM, SINIF 1, 1VA	\$14,00
TK30805102	AKIM TRAFOSU 80/5A, 30MM, SINIF 1, 1.5VA	\$14,00
TK301005201	AKIM TRAFOSU 100/5A, 30MM, SINIF 0.5, 1VA	\$14,29
TK301255201	AKIM TRAFOSU 125/5A, 30MM, SINIF 0.5, 1VA	\$15,00
TK302005205	AKIM TRAFOSU 200/5A, 30MM, SINIF 0.5, 5VA	\$13,14
TK302505205	AKIM TRAFOSU 250/5A, 30MM, SINIF 0.5, 5VA	\$13,14
TK303005205	AKIM TRAFOSU 300/5A, 30MM, SINIF 0.5, 5VA	\$13,14
TK304005205	AKIM TRAFOSU 400/5A, 30MM, SINIF 0.5, 5VA	\$13,14
TK305005205	AKIM TRAFOSU 500/5A, 30MM, SINIF 0.5, 5VA	\$13,14
TK306005205	AKIM TRAFOSU 600/5A, 30MM, SINIF 0.5, 5VA	\$13,14
TK302505207	AKIM TRAFOSU 250/5A, 30MM, SINIF 0.5, 10VA	\$15,00
TK303005207	AKIM TRAFOSU 300/5A, 30MM, SINIF 0.5, 10VA	\$14,50
TK304005207	AKIM TRAFOSU 400/5A, 30MM, SINIF 0.5, 10VA	\$12,86
TK305005207	AKIM TRAFOSU 500/5A, 30MM, SINIF 0.5, 10VA	\$12,86
TK306005207	AKIM TRAFOSU 600/5A, 30MM, SINIF 0.5, 10VA	\$12,86
TK30A755104	AKIM TRAFOSU 75/5A, 30MM, SINIF 1, 3.75VA	\$30,00
TK30A805105	AKIM TRAFOSU 80/5A, 30MM, SINIF 1, 5VA	\$30,00
TK30A1005204	AKIM TRAFOSU 100/5A, 30MM, SINIF 0.5, 3.75VA	\$22,00
TK30A1255205	AKIM TRAFOSU 125/5A, 30MM, SINIF 0.5, 5VA	\$22,00
TK30A1505205	AKIM TRAFOSU 150/5A, 30MM, SINIF 0.5, 5VA	\$22,00
TK30A1605205	AKIM TRAFOSU 160/5A, 30MM, SINIF 0.5, 5VA	\$22,00
TK30A2005207	AKIM TRAFOSU 200/5A, 30MM, SINIF 0.5, 10VA	\$24,00
TK402005203	AKIM TRAFOSU 200/5A, 40MM, SINIF 0.5, 2.5VA	\$13,00
TK402505203	AKIM TRAFOSU 250/5A, 40MM, SINIF 0.5, 2.5VA	\$13,00
TK403005203	AKIM TRAFOSU 300/5A, 40MM, SINIF 0.5, 2.5VA	\$13,00
TK404005205	AKIM TRAFOSU 400/5A, 40MM, SINIF 0.5, 5VA	\$14,20
TK405005205	AKIM TRAFOSU 500/5A, 40MM, SINIF 0.5, 5VA	\$14,20
TK406005205	AKIM TRAFOSU 600/5A, 40MM, SINIF 0.5, 5VA	\$15,00
TK404005207	AKIM TRAFOSU 400/5A, 40MM, SINIF 0.5, 10VA	\$16,00
TK405005207	AKIM TRAFOSU 500/5A, 40MM, SINIF 0.5, 10VA	\$15,00
TK406005207	AKIM TRAFOSU 600/5A, 40MM, SINIF 0.5, 10VA	\$15,00
TK408005207	AKIM TRAFOSU 800/5A, 40MM, SINIF 0.5, 10VA	\$15,40

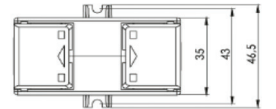
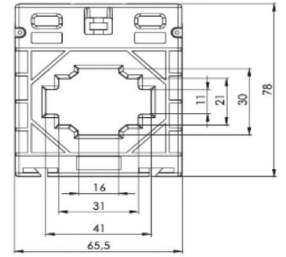
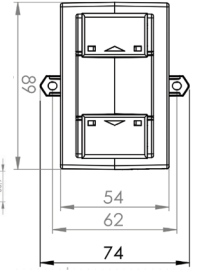
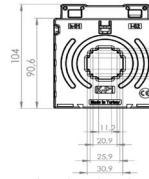
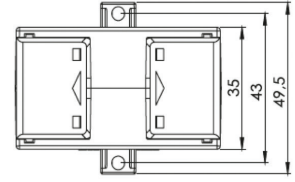
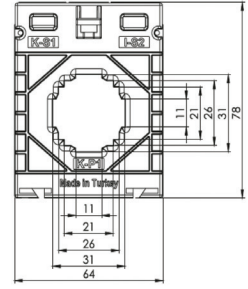

DELİKLİ TİP AKIM TRAFOSU

TK40A1505205	AKIM TRAFOSU 150/5A, 40MM, SINIF 0.5, 5VA	\$22,80
TK40A2005205	AKIM TRAFOSU 200/5A, 40MM, SINIF 0.5, 5VA	\$21,50
TK40A2505205	AKIM TRAFOSU 250/5A, 40MM, SINIF 0.5, 5VA	\$21,50
TK40A3005205	AKIM TRAFOSU 300/5A, 40MM, SINIF 0.5, 5VA	\$22,00
TK40A2005207	AKIM TRAFOSU 200/5A, 40MM, SINIF 0.5, 10VA	\$31,40
TK40A2505207	AKIM TRAFOSU 250/5A, 40MM, SINIF 0.5, 10VA	\$22,60
TK40A3005207	AKIM TRAFOSU 300/5A, 40MM, SINIF 0.5, 10VA	\$23,20
TK606005207	AKIM TRAFOSU 600/5A, 60MM, SINIF 0.5, 10VA	\$17,63
TK608005207	AKIM TRAFOSU 800/5A, 60MM, SINIF 0.5, 10VA	\$19,63
TK606005209	AKIM TRAFOSU 600/5A, 60MM, SINIF 0.5, 15VA	\$17,63
TK608005209	AKIM TRAFOSU 800/5A, 60MM, SINIF 0.5, 15VA	\$19,63
TK6010005209	AKIM TRAFOSU 1000/5A, 60MM, SINIF 0.5, 15VA	\$21,49
TK6012005209	AKIM TRAFOSU 1200/5A, 60MM, SINIF 0.5, 15VA	\$22,86
TK6012505209	AKIM TRAFOSU 1250/5A, 60MM, SINIF 0.5, 15VA	\$23,17
TK808005209	AKIM TRAFOSU 800/5A, 80MM, SINIF 0.5, 15VA	\$21,54
TK8010005209	AKIM TRAFOSU 1000/5A, 80MM, SINIF 0.5, 15VA	\$22,86
TK8012005209	AKIM TRAFOSU 1200/5A, 80MM, SINIF 0.5, 15VA	\$24,34
TK8012505209	AKIM TRAFOSU 1250/5A, 80MM, SINIF 0.5, 15VA	\$24,60
TK8015005209	AKIM TRAFOSU 1500/5A, 80MM, SINIF 0.5, 15VA	\$28,83
TK8016005209	AKIM TRAFOSU 1600/5A, 80MM, SINIF 0.5, 15VA	\$27,63
TK8015005209	AKIM TRAFOSU 1500/5A, 80MM, SINIF 0.5, 15VA	\$30,00
TK8016005209	AKIM TRAFOSU 1600/5A, 80MM, SINIF 0.5, 15VA	\$30,00
TK8020005212	AKIM TRAFOSU 2000/5A, 80MM, SINIF 0.5, 30VA	\$30,49
TK10010005209	AKIM TRAFOSU 1000/5A, 100MM, SINIF 0.5, 15VA	\$25,06
TK10012005209	AKIM TRAFOSU 1200/5A, 100MM, SINIF 0.5, 15VA	\$25,83
TK10012505209	AKIM TRAFOSU 1250/5A, 100MM, SINIF 0.5, 15VA	\$26,11
TK10015005209	AKIM TRAFOSU 1500/5A, 100MM, SINIF 0.5, 15VA	\$27,60
TK10016005212	AKIM TRAFOSU 1600/5A, 100MM, SINIF 0.5, 30VA	\$28,11
TK10020005212	AKIM TRAFOSU 2000/5A, 100MM, SINIF 0.5, 30VA	\$33,66
TK10025005212	AKIM TRAFOSU 2500/5A, 100MM, SINIF 0.5, 30VA	\$35,89
TK10030005212	AKIM TRAFOSU 3000/5A, 100MM, SINIF 0.5, 30VA	\$45,23
TK10032005212	AKIM TRAFOSU 3200/5A, 100MM, SINIF 0.5, 30VA	\$47,09
TK10040005212	AKIM TRAFOSU 4000/5A, 100MM, SINIF 0.5, 30VA	\$56,20

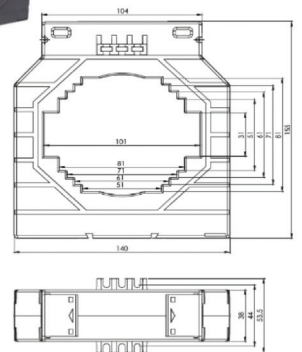
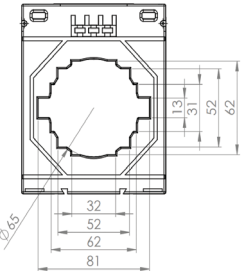
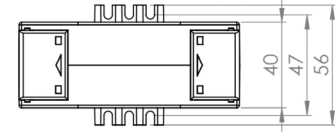
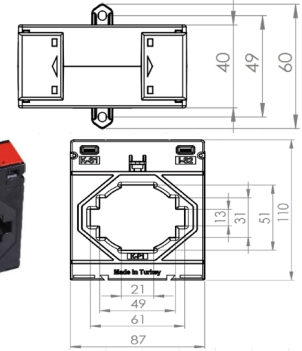
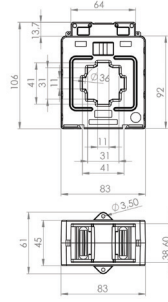
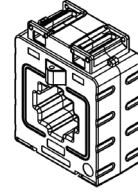
YENİ

FİYAT LİSTESİ

DELİKLİ TİP AKIM TRAFOSU

Model	Özellikler	Fiyat	Resim	
TK60D5005207	DAR TIP AKIM TRAFOSU, 500/5A, 60MM, SINIF 0.5, 10VA	\$19,23	<p>YENİ</p>	
TK60D6005209	DAR TIP AKIM TRAFOSU, 600/5A, 60MM, SINIF 0.5, 15VA	\$19,54		
TK60D7505209	DAR TIP AKIM TRAFOSU, 750/5A, 60MM, SINIF 0.5, 15VA	\$22,26		
TK60D8005209	DAR TIP AKIM TRAFOSU, 800/5A, 60MM, SINIF 0.5, 15VA	\$21,71		
TK60D10005209	DAR TIP AKIM TRAFOSU, 1000/5A, 60MM, SINIF 0.5, 15VA	\$22,03		
TK60D12005209	DAR TIP AKIM TRAFOSU, 1200/5A, 60MM, SINIF 0.5, 15VA	\$24,71		
TK60D12505209	DAR TIP AKIM TRAFOSU, 1250/5A, 60MM, SINIF 0.5, 15VA	\$25,29		
TK60D15005209	DAR TIP AKIM TRAFOSU, 1500/5A, 60MM, SINIF 0.5, 15VA	\$28,54		
TK60D16005212	DAR TIP AKIM TRAFOSU, 1600/5A, 60MM, SINIF 0.5, 30VA	\$29,06		
TK60D20005212	DAR TIP AKIM TRAFOSU, 2000/5A, 60MM, SINIF 0.5, 30VA	\$36,54		
TK12020005212	AKIM TRAFOSU 2000/5A, 120x70MM, SINIF 70MM, CLASS 0.5, 30VA	\$57,00		
TK12025005212	AKIM TRAFOSU 2500/5A, 120x70MM, SINIF 70MM, CLASS 0.5, 30VA	\$67,00		
TK12030005212	AKIM TRAFOSU 3000/5A, 120x70MM, SINIF 70MM, CLASS 0.5, 30VA	\$72,86		
TK12032005212	AKIM TRAFOSU 3200/5A, 120x70MM, SINIF 70MM, CLASS 0.5, 30VA	\$75,00		
TK12040005212	AKIM TRAFOSU 4000/5A, 120x70MM, SINIF 70MM, CLASS 0.5, 30VA	\$98,86		
TK12050005212	AKIM TRAFOSU 5000/5A, 120x70MM, SINIF 70MM, CLASS 0.5, 30VA	\$115,71		
DK12512005209	AKIM TRAFOSU 1200/5A, 125MM, SINIF 0.5, 15VA	\$30,00		
DK12512505209	AKIM TRAFOSU 1250/5A, 125MM, SINIF 0.5, 15VA	\$30,57		
DK12515005212	AKIM TRAFOSU 1500/5A, 125MM, SINIF 0.5, 30VA	\$33,74		
DK12516005212	AKIM TRAFOSU 1600/5A, 125MM, SINIF 0.5, 30VA	\$34,29		
DK12520005212	AKIM TRAFOSU 2000/5A, 125MM, SINIF 0.5, 30VA	\$40,00		
DK12525005212	AKIM TRAFOSU 2500/5A, 125MM, SINIF 0.5, 30VA	\$45,71		
DK12530005212	AKIM TRAFOSU 3000/5A, 125MM, SINIF 0.5, 30VA	\$54,86		
DK12532005212	AKIM TRAFOSU 3200/5A, 125MM, SINIF 0.5, 30VA	\$57,14		
DK12540005212	AKIM TRAFOSU 4000/5A, 125MM, SINIF 0.5, 30VA	\$71,43		

FİYAT LİSTESİ
AYRILABİLİR AKIM TRAFOLARI

AYRILABİLİR AKIM TRAFOLARI		
SK582505903	Ayrılabilir Akım Trafosu 50x80mm 250/5A	\$64,98
SK583005903	Ayrılabilir Akım Trafosu 50x80mm 300/5A	\$64,98
SK584005903	Ayrılabilir Akım Trafosu 50x80mm 400/5A	\$64,98
SK585005903	Ayrılabilir Akım Trafosu 50x80mm 500/5A	\$64,98
SK586005105	Ayrılabilir Akım Trafosu 50x80mm 600/5A	\$64,98
SK587505105	Ayrılabilir Akım Trafosu 50x80mm 750/5A	\$64,98
SK588005105	Ayrılabilir Akım Trafosu 50x80mm 800/5A	\$64,98
SK5810005105	Ayrılabilir Akım Trafosu 50x80mm 1000/5A	\$64,98
SK5812005105	Ayrılabilir Akım Trafosu 50x80mm 1200/5A	\$69,30
SK5812505105	Ayrılabilir Akım Trafosu 50x80mm 1250/5A	\$69,30
SK5815005105	Ayrılabilir Akım Trafosu 50x80mm 1500/5A	\$69,30
SK5816005207	Ayrılabilir Akım Trafosu 50x80mm 1600/5A	\$69,30
SK884005103	Ayrılabilir Akım Trafosu 80x80mm 400/5A	\$74,10
SK885005103	Ayrılabilir Akım Trafosu 80x80mm 500/5A	\$74,10
SK886005103	Ayrılabilir Akım Trafosu 80x80mm 600/5A	\$74,10
SK887505105	Ayrılabilir Akım Trafosu 80x80mm 750/5A	\$74,10
SK888005107	Ayrılabilir Akım Trafosu 80x80mm 800/5A	\$74,10
SK8810005107	Ayrılabilir Akım Trafosu 80x80mm 1000/5A	\$74,10
SK8812005107	Ayrılabilir Akım Trafosu 80x80mm 1200/5A	\$77,70
SK8812505107	Ayrılabilir Akım Trafosu 80x80mm 1250/5A	\$77,70
SK8815005107	Ayrılabilir Akım Trafosu 80x80mm 1500/5A	\$81,90
SK8816005207	Ayrılabilir Akım Trafosu 80x80mm 1600/5A	\$81,90
SK8820005207	Ayrılabilir Akım Trafosu 80x80mm 2000/5A	\$84,00
SK8124005903	Ayrılabilir Akım Trafosu 80x120mm 400/5A	\$94,50
SK8125005103	Ayrılabilir Akım Trafosu 80x120mm 500/5A	\$94,50
SK8126005105	Ayrılabilir Akım Trafosu 80x120mm 600/5A	\$94,50
SK8128005107	Ayrılabilir Akım Trafosu 80x120mm 800/5A	\$94,50
SK81210005107	Ayrılabilir Akım Trafosu 80x120mm 1000/5A	\$94,50
SK81212005207	Ayrılabilir Akım Trafosu 80x120mm 1200/5A	\$94,50
SK81212505207	Ayrılabilir Akım Trafosu 80x120mm 1250/5A	\$94,50
SK81215005209	Ayrılabilir Akım Trafosu 80x120mm 1500/5A	\$99,75
SK81216005209	Ayrılabilir Akım Trafosu 80x120mm 1600/5A	\$99,75
SK81220005209	Ayrılabilir Akım Trafosu 80x120mm 2000/5A	\$105,00
SK81225005209	Ayrılabilir Akım Trafosu 80x120mm 2500/5A	\$110,25
SK81230005212	Ayrılabilir Akım Trafosu 80x120mm 3000/5A	\$115,50

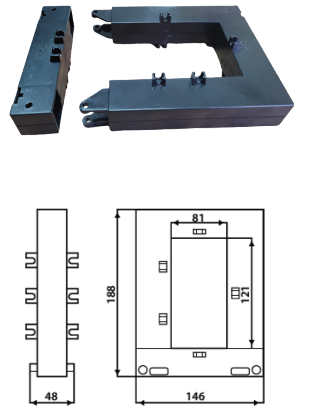
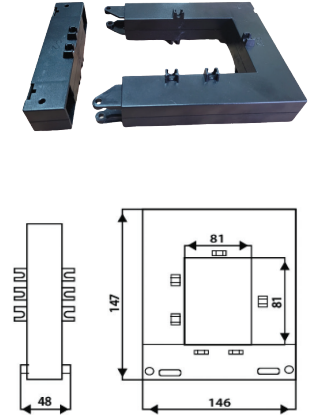
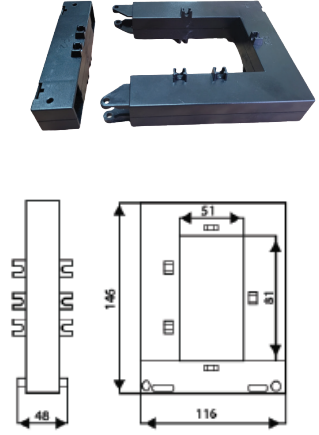

AYRILABİLİR AKIM TRAFOLARI

SK81610005207	Ayrılabilir Akım Trafosu 80x160mm 1000/5A	\$171,00	
SK81612005207	Ayrılabilir Akım Trafosu 80x160mm 1200/5A	\$171,00	
SK81612505207	Ayrılabilir Akım Trafosu 80x160mm 1250/5A	\$171,00	
SK81615005209	Ayrılabilir Akım Trafosu 80x160mm 1500/5A	\$171,00	
SK81616005209	Ayrılabilir Akım Trafosu 80x160mm 1600/5A	\$171,00	
SK81620005209	Ayrılabilir Akım Trafosu 80x160mm 2000/5A	\$182,40	
SK81625005209	Ayrılabilir Akım Trafosu 80x160mm 2500/5A	\$193,80	
SK81630005212	Ayrılabilir Akım Trafosu 80x160mm 3000/5A	\$199,50	
SK81640005212	Ayrılabilir Akım Trafosu 80x160mm 4000/5A	\$205,20	
SK81650005212	Ayrılabilir Akım Trafosu 80x160mm 5000/5A	\$216,60	
SK82020005207	Ayrılabilir Akım Trafosu 80x200mm 2000/5A	\$229,95	YENİ
SK82025005209	Ayrılabilir Akım Trafosu 80x200mm 2500/5A	\$233,10	
SK82030005209	Ayrılabilir Akım Trafosu 80x200mm 3000/5A	\$236,25	
SK82040005212	Ayrılabilir Akım Trafosu 80x200mm 4000/5A	\$241,50	
SK82050005212	Ayrılabilir Akım Trafosu 80x200mm 5000/5A	\$246,75	
SK82060005212	Ayrılabilir Akım Trafosu 80x200mm 6000/5A	\$262,50	
SK82063005212	Ayrılabilir Akım Trafosu 80x200mm 6300/5A	\$273,00	
MSK241005901	Ayrılabilir Akım Trafosu 24x24mm 100A/5A	\$29,40	
MSK241255901	Ayrılabilir Akım Trafosu 24x24mm 125A/5A	\$29,40	
MSK241505902	Ayrılabilir Akım Trafosu 24x24mm 150A/5A	\$29,40	
MSK241605902	Ayrılabilir Akım Trafosu 24x24mm 160A/5A	\$29,40	
MSK242005903	Ayrılabilir Akım Trafosu 24x24mm 200A/5A	\$29,40	
MSK242505101	Ayrılabilir Akım Trafosu 24x24mm 250A/5A	\$29,40	
MSK243005101	Ayrılabilir Akım Trafosu 24x24mm 300A/5A	\$29,40	
MSK361005901	Ayrılabilir Akım Trafosu 36x36mm 100A/5A	\$34,65	
MSK361255901	Ayrılabilir Akım Trafosu 36x36mm 125A/5A	\$34,65	
MSK361505901	Ayrılabilir Akım Trafosu 36x36mm 150A/5A	\$34,65	
MSK361605901	Ayrılabilir Akım Trafosu 36x36mm 160A/5A	\$34,65	
MSK362005901	Ayrılabilir Akım Trafosu 36x36mm 200A/5A	\$34,65	
MSK362505903	Ayrılabilir Akım Trafosu 36x36mm 250A/5A	\$34,65	
MSK363005101	Ayrılabilir Akım Trafosu 36x36mm 300A/5A	\$34,65	
MSK364005102	Ayrılabilir Akım Trafosu 36x36mm 400A/5A	\$34,65	
MSK501505901	Ayrılabilir Akım Trafosu 50x50mm 150A/5A	\$46,20	
MSK501605901	Ayrılabilir Akım Trafosu 50x50mm 160A/5A	\$46,20	
MSK502005901	Ayrılabilir Akım Trafosu 50x50mm 200A/5A	\$46,20	
MSK502505901	Ayrılabilir Akım Trafosu 50x50mm 250A/5A	\$46,20	
MSK503005103	Ayrılabilir Akım Trafosu 50x50mm 300A/5A	\$46,20	
MSK504005103	Ayrılabilir Akım Trafosu 50x50mm 400A/5A	\$46,20	
MSK505005105	Ayrılabilir Akım Trafosu 50x50mm 500A/5A	\$47,25	
MSK506005105	Ayrılabilir Akım Trafosu 50x50mm 600A/5A	\$48,30	
MSK508005203	Ayrılabilir Akım Trafosu 50x50mm 800A/5A	\$49,35	

FIYAT LİSTESİ
BARALI AKIM TRAFOLARI

BARALI AKIM TRAFOLARI		
BK55205	AKIM TRAFOSU, BARALI 5/5A, SINIF 0.5, 5VA	\$25,71
BK105205	AKIM TRAFOSU, BARALI 10/5A, SINIF 0.5, 5VA	\$21,43
BK155205	AKIM TRAFOSU, BARALI 15/5A, SINIF 0.5, 5VA	\$21,43
BK205205	AKIM TRAFOSU, BARALI 20/5A, SINIF 0.5, 5VA	\$21,43
BK255205	AKIM TRAFOSU, BARALI 25/5A, SINIF 0.5, 5VA	\$21,43
BK305205	AKIM TRAFOSU, BARALI 30/5A, SINIF 0.5, 5VA	\$21,43
BK405205	AKIM TRAFOSU, BARALI 40/5A, SINIF 0.5, 5VA	\$22,86
BK505205	AKIM TRAFOSU, BARALI 50/5A, SINIF 0.5, 5VA	\$23,71
BK605205	AKIM TRAFOSU, BARALI 60/5A, SINIF 0.5, 5VA	\$23,71
BK805205	AKIM TRAFOSU, BARALI 80/5A, SINIF 0.5, 5VA	\$23,71
BK1005205	AKIM TRAFOSU, BARALI 100/5A, SINIF 0.5, 5VA	\$24,97
BK1505205	AKIM TRAFOSU, BARALI 150/5A, SINIF 0.5, 5VA	\$23,71
BK55207	AKIM TRAFOSU, BARALI 5/5A, SINIF 0.5, 10VA	\$23,71
BK105207	AKIM TRAFOSU, BARALI 10/5A, SINIF 0.5, 10VA	\$23,71
BK155207	AKIM TRAFOSU, BARALI 15/5A, SINIF 0.5, 10VA	\$23,71
BK205207	AKIM TRAFOSU, BARALI 20/5A, SINIF 0.5, 10VA	\$23,71
BK255207	AKIM TRAFOSU, BARALI 25/5A, SINIF 0.5, 10VA	\$23,71
BK305207	AKIM TRAFOSU, BARALI 30/5A, SINIF 0.5, 10VA	\$23,71
BK405207	AKIM TRAFOSU, BARALI 40/5A, SINIF 0.5, 10VA	\$24,29
BK505207	AKIM TRAFOSU, BARALI 50/5A, SINIF 0.5, 10VA	\$25,43
BK605207	AKIM TRAFOSU, BARALI 60/5A, SINIF 0.5, 10VA	\$25,43
BK805207	AKIM TRAFOSU, BARALI 80/5A, SINIF 0.5, 10VA	\$25,43
BK1005207	AKIM TRAFOSU, BARALI 100/5A, SINIF 0.5, 10VA	\$25,73
BK1505207	AKIM TRAFOSU, BARALI 150/5A, SINIF 0.5, 10VA	\$25,43

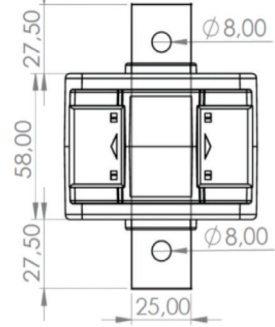
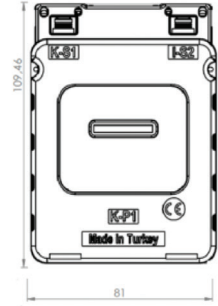
FIYAT LİSTESİ
KAPALI TİP AKIM TRAFOLARI

KAPALI AKIM TRAFOLARI		
BK1C15101	Kapalı Tip Akım Trafosu 1/5A, CLASS 1, 1VA	\$21,00
BK1C25101	Kapalı Tip Akım Trafosu 2.5/5A, CLASS 1, 1VA	\$21,00
BK1C55101	Kapalı Tip Akım Trafosu , 5/5A, CLASS 1, 1VA	\$21,00
BK1C105102	Kapalı Tip Akım Trafosu , 10/5A, CLASS 1, 1.5VA	\$21,00
BK1C155102	Kapalı Tip Akım Trafosu, 15/5A, CLASS 1, 1.5VA	\$21,00
BK1C205102	Kapalı Tip Akım Trafosu, 20/5A, CLASS 1, 1.5VA	\$21,00
BK1C255102	Kapalı Tip Akım Trafosu, 25/5A, CLASS 1, 1.5VA	\$21,00
BK1C305201	Kapalı Tip Akım Trafosu, 30/5A, CLASS 0.5, 1VA	\$21,00
BK1C405201	Kapalı Tip Akım Trafosu 40/5A, CLASS 0.5, 1VA	\$21,00
BK1C505201	Kapalı Tip Akım Trafosu, 50/5A, CLASS 0.5, 1VA	\$21,00

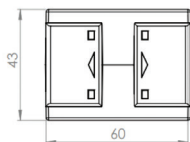
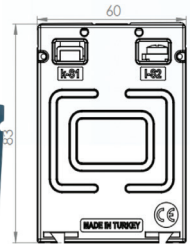

FİYAT LİSTESİ
MÜHÜRLÜ AKIM TRAFOLARI

MÜHÜRLÜ AKIM TRAFOLARI			
TK30A2005207-M	AKIM TRAFOSU 200/5A, 30MM, SINIF 0.5, 10VA, MÜHÜRLÜ	\$28,29	
TK302505207-M	AKIM TRAFOSU 250/5A, 30MM, SINIF 0.5, 10VA, MÜHÜRLÜ	\$18,86	
TK303005207-M	AKIM TRAFOSU 300/5A, 30MM, SINIF 0.5, 10VA, MÜHÜRLÜ	\$18,86	
TK304005207-M	AKIM TRAFOSU 400/5A, 30MM, SINIF 0.5, 10VA, MÜHÜRLÜ	\$16,29	
TK305005207-M	AKIM TRAFOSU 500/5A, 30MM, SINIF 0.5, 10VA, MÜHÜRLÜ	\$16,29	
TK306005207-M	AKIM TRAFOSU 600/5A, 30MM, SINIF 0.5, 10VA, MÜHÜRLÜ	\$16,29	
TK404005207-M	AKIM TRAFOSU 400/5A, 40MM, SINIF 0.5, 10VA, MÜHÜRLÜ	\$19,14	
TK405005207-M	AKIM TRAFOSU 500/5A, 40MM, SINIF 0.5, 10VA, MÜHÜRLÜ	\$18,57	
TK406005207-M	AKIM TRAFOSU 600/5A, 40MM, SINIF 0.5, 10VA, MÜHÜRLÜ	\$18,57	
TK408005207-M	AKIM TRAFOSU 800/5A, 40MM, SINIF 0.5, 10VA, MÜHÜRLÜ	\$18,57	
TK606005207-M	AKIM TRAFOSU 600/5A, 60MM, SINIF 0.5, 10VA, MÜHÜRLÜ	\$21,14	
TK608005207-M	AKIM TRAFOSU 800/5A, 60MM, SINIF 0.5, 10VA, MÜHÜRLÜ	\$22,86	
TK6010005207-M	AKIM TRAFOSU 1000/5A, 60MM, SINIF 0.5, 10VA, MÜHÜRLÜ	\$24,86	
TK6012005207-M	AKIM TRAFOSU 1200/5A, 60MM, SINIF 0.5, 10VA, MÜHÜRLÜ	\$26,29	
TK6012505207-M	AKIM TRAFOSU 1250/5A, 60MM, SINIF 0.5, 10VA, MÜHÜRLÜ	\$26,71	
TK8015005209-M	AKIM TRAFOSU 1500/5A, 80MM, SINIF 0.5, 15VA, MÜHÜRLÜ	\$32,29	
TK8016005209-M	AKIM TRAFOSU 1600/5A, 80MM, SINIF 0.5, 15VA, MÜHÜRLÜ	\$32,29	
TK10016005212-M	AKIM TRAFOSU 1600/5A, 100MM, SINIF 0.5, 30VA, MÜHÜRLÜ	\$32,00	
TK10020005209-M	AKIM TRAFOSU 2000/5A, 100MM, SINIF 0.5, 15VA, MÜHÜRLÜ	\$37,14	
TK10025005209-M	AKIM TRAFOSU 2500/5A, 100MM, SINIF 0.5, 15VA, MÜHÜRLÜ	\$39,29	
TK10030005209-M	AKIM TRAFOSU 3000/5A, 100MM, SINIF 0.5, 15VA, MÜHÜRLÜ	\$49,71	
TK10032005212-M	AKIM TRAFOSU 3200/5A, 100MM, SINIF 0.5, 30VA, MÜHÜRLÜ	\$51,43	
TK10040005212-M	AKIM TRAFOSU 4000/5A, 100MM, SINIF 0.5, 30VA, MÜHÜRLÜ	\$60,86	
BK55207-M	AKIM TRAFOSU, BARALI 5/5A, SINIF 0.5, 10VA, MÜHÜRLÜ	\$26,97	
BK105207-M	AKIM TRAFOSU, BARALI 10/5A, SINIF 0.5, 10VA, MÜHÜRLÜ	\$26,97	
BK155207-M	AKIM TRAFOSU, BARALI 15/5A, SINIF 0.5, 10VA, MÜHÜRLÜ	\$26,97	
BK205207-M	AKIM TRAFOSU, BARALI 20/5A, SINIF 0.5, 10VA, MÜHÜRLÜ	\$26,97	
BK255207-M	AKIM TRAFOSU, BARALI 25/5A, SINIF 0.5, 10VA, MÜHÜRLÜ	\$26,97	
BK305207-M	AKIM TRAFOSU, BARALI 30/5A, SINIF 0.5, 10VA, MÜHÜRLÜ	\$26,97	
BK405207-M	AKIM TRAFOSU, BARALI 40/5A, SINIF 0.5, 10VA, MÜHÜRLÜ	\$27,54	
BK505207-M	AKIM TRAFOSU, BARALI 50/5A, SINIF 0.5, 10VA, MÜHÜRLÜ	\$28,69	
BK605207-M	AKIM TRAFOSU, BARALI 60/5A, SINIF 0.5, 10VA, MÜHÜRLÜ	\$28,69	
BK805207-M	AKIM TRAFOSU, BARALI 80/5A, SINIF 0.5, 10VA, MÜHÜRLÜ	\$28,69	
BK1005207-M	AKIM TRAFOSU, BARALI 100/5A, SINIF 0.5, 10VA, MÜHÜRLÜ	\$28,99	
BK1505207-M	AKIM TRAFOSU, BARALI 150/5A, SINIF 0.5, 10VA, MÜHÜRLÜ	\$28,69	

RÖLE VE SOKETLER

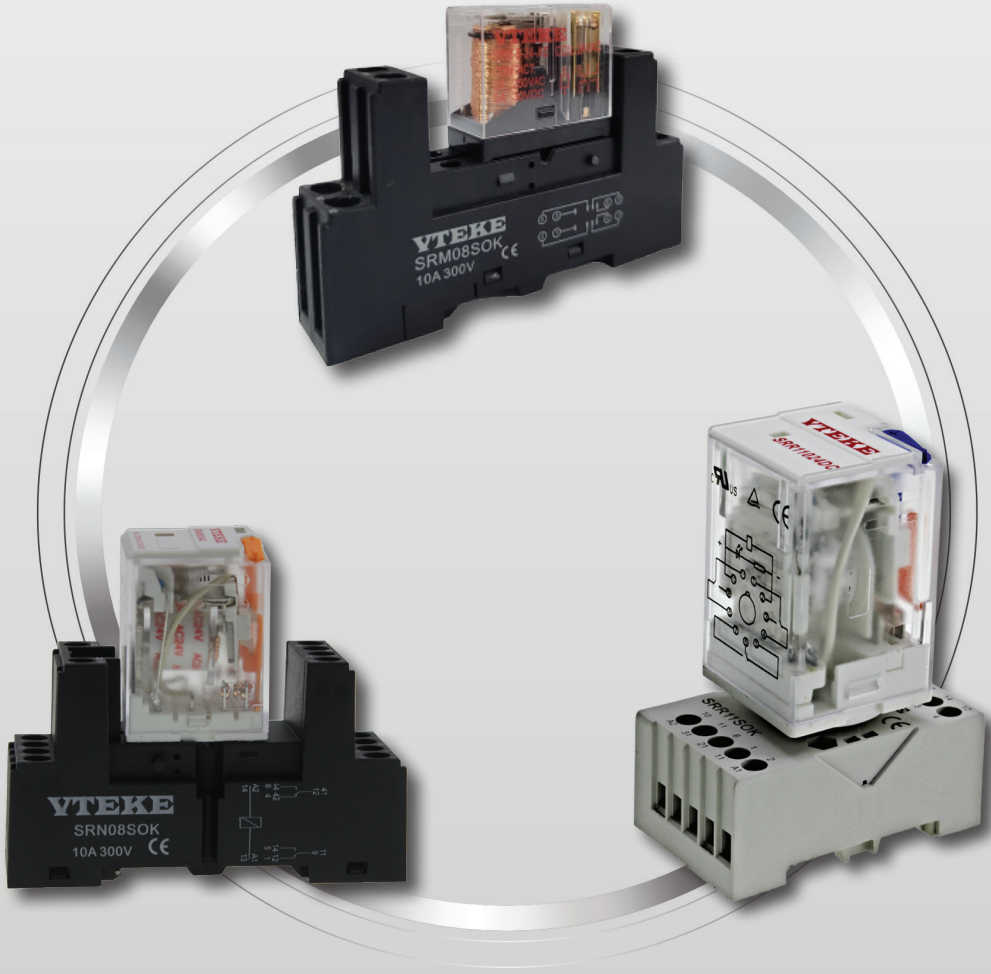

VTEKE®

FİYAT LİSTESİ
RÖLELER VE RÖLE SOKETLERİ

SRM SERİSİ RÖLELER VE SOKETLER		
SRM-8-012-AC	RÖLE 8PIN 2KONTAKT, 12VAC, 5A	\$4,40
SRM-8-024-AC	RÖLE 8PIN 2KONTAKT, 24VAC, 5A	\$4,40
SRM-8-048-AC	RÖLE 8PIN 2KONTAKT, 48VAC, 5A	\$5,86
SRM-8-110-AC	RÖLE 8PIN 2KONTAKT, 110VAC, 5A	\$5,86
SRM-8-230-AC	RÖLE 8PIN 2KONTAKT, 230VAC, 5A	\$5,86
SRM-8-012-DC	RÖLE 8PIN 2KONTAKT, 12VDC, 5A	\$2,82
SRM-8-024-DC	RÖLE 8PIN 2KONTAKT, 24VDC, 5A	\$2,82
SRM-8-048-DC	RÖLE 8PIN 2KONTAKT, 48VDC, 5A	\$3,80
SRM-8-110-DC	RÖLE 8PIN 2KONTAKT, 110VDC, 5A	\$4,05
SRM-08-SOK	DÜZ SOKET 8 PİN SRM SERİSİ	\$3,15
SRN SERİSİ RÖLELER VE SOKETLER		
SRN-08-012-AC	RÖLE 8PIN 2KONTAKT, 12VAC,BAYRAKLI VE LEDLI, 5A	\$5,43
SRN-08-024-AC	RÖLE 8PIN 2KONTAKT, 24VAC,BAYRAKLI VE LEDLI, 5A	\$5,43
SRN-08-048-AC	RÖLE 8PIN 2KONTAKT, 48VAC,BAYRAKLI VE LEDLI, 5A	\$5,43
SRN-08-230-AC	RÖLE 8PIN 2KONTAKT, 230VAC,BAYRAKLI VE LEDLI, 5A	\$5,43
SRN-08-012-DC	RÖLE 8PIN 2KONTAKT, 12VDC,BAYRAKLI VE LEDLI, 5A	\$5,43
SRN-08-024-DC	RÖLE 8PIN 2KONTAKT, 24VDC, BAYRAKLI VE LEDLI, 5A	\$5,43
SRN-11-024-AC	RÖLE 11PIN 3KONTAKT, 24VAC,BAYRAKLI VE LEDLI, 5A	\$5,43
SRN-11-230-AC	RÖLE 11PIN 3KONTAKT, 230VAC,BAYRAKLI VE LEDLI, 5A	\$5,43
SRN-11-012-DC	RÖLE 11PIN 3KONTAKT, 12VDC, BAYRAKLI VE LEDLI, 5A	\$5,43
SRN-11-024-DC	RÖLE 11PIN 3KONTAKT, 24VDC,BAYRAKLI VE LEDLI, 5A	\$5,43
SRN-14-012-AC	RÖLE 14PIN 4KONTAKT, 12VAC,BAYRAKLI VE LEDLI, 5A	\$5,43
SRN-14-024-AC	RÖLE 14PIN 4KONTAKT, 24VAC,BAYRAKLI VE LEDLI, 5A	\$5,43
SRN-14-048-AC	RÖLE 14PIN 4KONTAKT, 48VAC,BAYRAKLI VE LEDLI, 5A	\$5,43
SRN-14-060-AC	RÖLE 14PIN 4KONTAKT, 60VAC,BAYRAKLI VE LEDLI, 5A	\$5,43
SRN-14-110-AC	RÖLE 14PIN 4KONTAKT, 110VAC,BAYRAKLI VE LEDLI, 5A	\$5,43
SRN-14-230-AC	RÖLE 14PIN 4KONTAKT, 230VAC,BAYRAKLI VE LEDLI, 5A	\$5,43
SRN-14-012-DC	RÖLE 14PIN 4KONTAKT, 12VDC,BAYRAKLI VE LEDLI, 5A	\$5,43
SRN-14-024-DC	RÖLE 14PIN 4KONTAKT, 24VDC,BAYRAKLI VE LEDLI, 5A	\$5,43
SRN-14-048-DC	RÖLE 14PIN 4KONTAKT, 48VDC,BAYRAKLI VE LEDLI, 5A	\$5,43
SRN-14-060-DC	RÖLE 14PIN 4KONTAKT, 60VDC,BAYRAKLI VE LEDLI, 5A	\$5,43
SRN-14-110-DC	RÖLE 14PIN 4KONTAKT, 110VDC,BAYRAKLI VE LEDLI, 5A	\$5,43
SRN-08-SOK	DÜZ SOKET 8 PİN SRN SERİSİ	\$3,26
SRN-11-SOK	DÜZ SOKET 11 PİN SRN SERİSİ	\$3,31
SRN-14-SOK	DÜZ SOKET 14 PİN SRN SERİSİ	\$3,37



SRR SERİSİ RÖLELER VE SOKETLER

SRR-08-024-AC	RÖLE 8PIN 2KONTAKT, 24VAC (YUVARLAK SOKET TİPİ), 10A	\$10,00
SRR-08-230-AC	RÖLE 8PIN 2KONTAKT, 230VAC (YUVARLAK SOKET TİPİ), 10A	\$10,00
SRR-08-012-DC	RÖLE 8PIN 2KONTAKT, 12VDC (YUVARLAK SOKET TİPİ), 10A	\$10,00
SRR-08-024-DC	RÖLE 8PIN 2KONTAKT, 24VDC (YUVARLAK SOKET TİPİ), 10A	\$10,00
SRR-11-024-AC	RÖLE 11PIN 3KONTAKT, 24VAC (YUVARLAK SOKET TİPİ), 10A	\$10,50
SRR-11-230-AC	RÖLE 11PIN 3KONTAKT, 230VAC (YUVARLAK SOKET TİPİ), 10A	\$10,50
SRR-11-012-DC	RÖLE 11PIN 3KONTAKT, 12VDC (YUVARLAK SOKET TİPİ), 10A	\$10,50
SRR-11-024-DC	RÖLE 11PIN 3KONTAKT, 24VDC (YUVARLAK SOKET TİPİ), 10A	\$10,50
SRR-11-048-DC	RÖLE 11PIN 3KONTAKT, 48VDC (YUVARLAK SOKET TİPİ), 10A	\$10,50
SRR-11-110-DC	RÖLE 11PIN 3KONTAKT, 110VDC (YUVARLAK SOKET TİPİ), 10A	\$10,50
SRR-11-220-DC	RÖLE 11PIN 3KONTAKT, 220VDC (YUVARLAK SOKET TİPİ), 10A	\$13,50
SRR-08-SOK	YUVARLAK SOKET 8 PİN - SRR SERİSİ	\$3,26
SRR-11-SOK	YUVARLAK SOKET 11 PİN - SRR SERİSİ	\$3,31

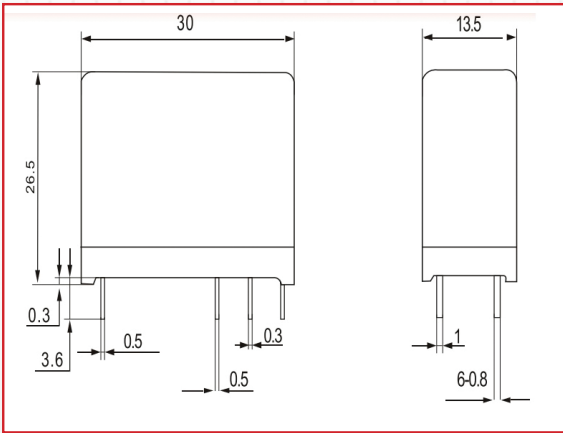
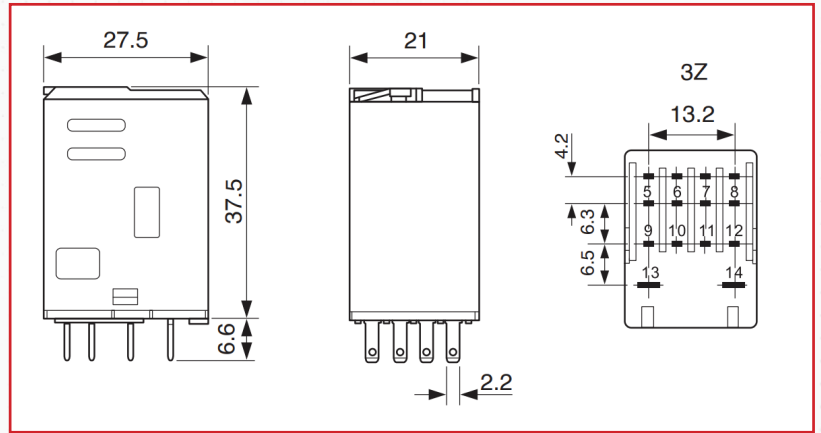
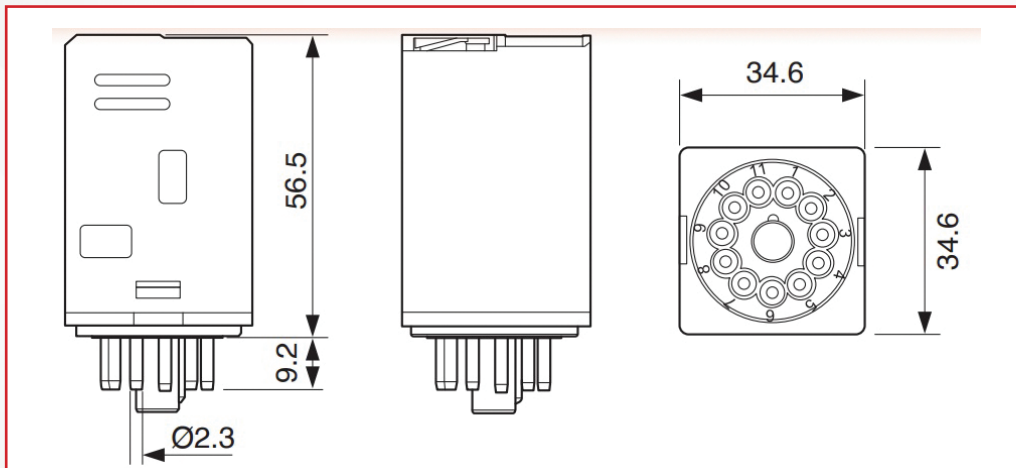
SRM SERİSİ

SRN SERİSİ

SRR SERİSİ

SİLİNDİRİK SİGORTA YUVALARI VE BUŞONLARI



VTEKE®

TEKNİK ÖZELLİKLER

PARAMETRE	FH-38	FH-51	FH-58
Anma Gerilimi	690VAC	690VAC	690VAC
Kesme Kapasitesi	50KA	50KA	100KA
Maks. Güç Kaybı	3W Maks.	5W Maks.	9.5W Maks.
Standart	IEC60269-2, IEC60947-3	IEC60269-2, IEC60947-3	IEC60947-3
Kullanım Kategorisi	AC-22B	AC-22B	AC-22B
Yükselti	2000m	2000m	2000m
Çalışma Sıcaklığı	-10°C - +50°C	-10°C - +50°C	-10°C - +50°C
Kablo Kesiti	Maks. 25mm ²	Maks. 35mm ²	Maks. 50mm ²
Tork	2-2.5Nm	2.5-3Nm	2.5-3Nm
Aleve Dayanıklılık (IEC60695-2-1)	960°C	960°C	960°C
Anma Darbe Dayanma Gerilimi	6kV	8kV	8kV

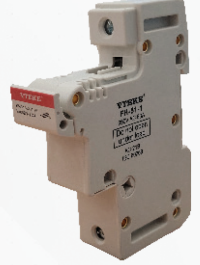

TEKNİK ÖZELLİKLER

PARAMETRE	DEĞER
Anma Gerilimi	500VAC
Kesme Kapasitesi	100KA
Anma Frekansı	45 - 62 Hz
Güç Kaybı	Maks. 6W
İşletme Sınıfı	gG
Standart	IEC60269-2
Yükselti	2000m
Çalışma Sıcaklığı	-10°C - +50°C, 48-85% RH
Sigorta Gövdesi	Seramik
Kontaklar	CuZn37, Nikel Alaşımli Bakır/ 5 Mikro Katman Gümüş Kaplama
Ark Söndürme Materyali	Kuvarz Kumu
Sigorta Elementi	Bakır



TİP	ANMA AKIMI	ÇAP (A)	UZUNLUK (B)
CFL38	0.5-32A	10.3±1	38±0.6
CFL51	6-50A	14.3±1	51±0.6-1
CFL58	16-25A	22.2±1	58±0.1-2

FİYAT LİSTESİ
SİLİNDİRİK SİGORTA YUVALARI VE BUŞONLARI

SİLİNDİRİK KARTUŞ SİGORTA 10 X 38			
FH-38-1	1P 10 X 38 SİLİNDİRİK KARTUŞ SİGORTA YUVASI	\$2,96	
FH-38-2	2P 10 X 38 SİLİNDİRİK KARTUŞ SİGORTA YUVASI	\$7,82	
FH-38-3	3P 10 X 38 SİLİNDİRİK KARTUŞ SİGORTA YUVASI	\$11,40	
FH-38-4	4P 10 X 38 SİLİNDİRİK KARTUŞ SİGORTA YUVASI	\$14,11	
FH-38D-1	1P 10 X 38 LEDLİ SİLİNDİRİK KARTUŞ SİGORTA YUVASI	\$3,89	
CFL38005	SİLİNDİRİK KARTUŞ SİGORTA BUŞONU 10*38 0.5A	\$0,80	
CFL38001	SİLİNDİRİK KARTUŞ SİGORTA BUŞONU 10*38 1A	\$0,80	
CFL38002	SİLİNDİRİK KARTUŞ SİGORTA BUŞONU 10*38 2A	\$0,80	
CFL38004	SİLİNDİRİK KARTUŞ SİGORTA BUŞONU 10*38 4A	\$0,80	
CFL38006	SİLİNDİRİK KARTUŞ SİGORTA BUŞONU 10*38 6A	\$0,80	
CFL38008	SİLİNDİRİK KARTUŞ SİGORTA BUŞONU 10*38 8A	\$0,80	
CFL38010	SİLİNDİRİK KARTUŞ SİGORTA BUŞONU 10*38 10A	\$0,80	
CFL38012	SİLİNDİRİK KARTUŞ SİGORTA BUŞONU 10*38 12A	\$0,80	
CFL38016	SİLİNDİRİK KARTUŞ SİGORTA BUŞONU 10*38 16A	\$0,80	
CFL38020	SİLİNDİRİK KARTUŞ SİGORTA BUŞONU 10*38 20A	\$0,80	
CFL38025	SİLİNDİRİK KARTUŞ SİGORTA BUŞONU 10*38 25A	\$0,80	
CFL38032	SİLİNDİRİK KARTUŞ SİGORTA BUŞONU 10*38 32A	\$0,80	

SİLİNDİRİK KARTUŞ SİGORTA 14X51			
FH-51-1	1P 14 X 51 SİLİNDİRİK KARTUŞ SİGORTA YUVASI	\$8,25	
FH-51-2	2P 14 X 51 SİLİNDİRİK KARTUŞ SİGORTA YUVASI	\$18,78	
FH-51-3	3P 14 X 51 SİLİNDİRİK KARTUŞ SİGORTA YUVASI	\$27,36	
CFL51006	SİLİNDİRİK KARTUŞ SİGORTA BUŞONU 14*51 6A	\$1,40	
CFL51008	SİLİNDİRİK KARTUŞ SİGORTA BUŞONU 14*51 8A	\$1,40	
CFL51010	SİLİNDİRİK KARTUŞ SİGORTA BUŞONU 14*51 10A	\$1,40	
CFL51012	SİLİNDİRİK KARTUŞ SİGORTA BUŞONU 14*51 12A	\$1,40	
CFL51016	SİLİNDİRİK KARTUŞ SİGORTA BUŞONU 14*51 16A	\$1,40	
CFL51020	SİLİNDİRİK KARTUŞ SİGORTA BUŞONU 14*51 20A	\$1,40	
CFL51025	SİLİNDİRİK KARTUŞ SİGORTA BUŞONU 14*51 25A	\$1,40	
CFL51032	SİLİNDİRİK KARTUŞ SİGORTA BUŞONU 14*51 32A	\$1,40	
CFL51040	SİLİNDİRİK KARTUŞ SİGORTA BUŞONU 14*51 40A	\$1,40	
CFL51050	SİLİNDİRİK KARTUŞ SİGORTA BUŞONU 14*51 50A	\$1,40	
CFL51063	SİLİNDİRİK KARTUŞ SİGORTA BUŞONU 14*51 63A	\$1,40	

SİLİNDİRİK KARTUŞ SİGORTA 22X58

FH-58-1	1P 22 X 58 SİLİNDİRİK KARTUŞ SİGORTA YUVASI	\$11,00	
FH-58-2	2P 22 X 58 SİLİNDİRİK KARTUŞ SİGORTA YUVASI	\$26,00	
FH-58-3	3P 22 X 58 SİLİNDİRİK KARTUŞ SİGORTA YUVASI	\$42,00	
CFL58016	SİLİNDİRİK KARTUŞ SİGORTA BUŞONU 22*58 16A	\$2,80	
CFL58020	SİLİNDİRİK KARTUŞ SİGORTA BUŞONU 22*58 20A	\$2,80	
CFL58025	SİLİNDİRİK KARTUŞ SİGORTA BUŞONU 22*58 25A	\$2,80	
CFL58032	SİLİNDİRİK KARTUŞ SİGORTA BUŞONU 22*58 32A	\$2,80	
CFL58040	SİLİNDİRİK KARTUŞ SİGORTA BUŞONU 22*58 40A	\$2,80	
CFL58050	SİLİNDİRİK KARTUŞ SİGORTA BUŞONU 22*58 50A	\$2,80	
CFL58063	SİLİNDİRİK KARTUŞ SİGORTA BUŞONU 22*58 63A	\$2,80	
CFL58080	SİLİNDİRİK KARTUŞ SİGORTA BUŞONU 22*58 80A	\$2,80	
CFL58100	SİLİNDİRİK KARTUŞ SİGORTA BUŞONU 22*58 100A	\$2,80	
CFL58125	SİLİNDİRİK KARTUŞ SİGORTA BUŞONU 22*58 125A	\$2,80	

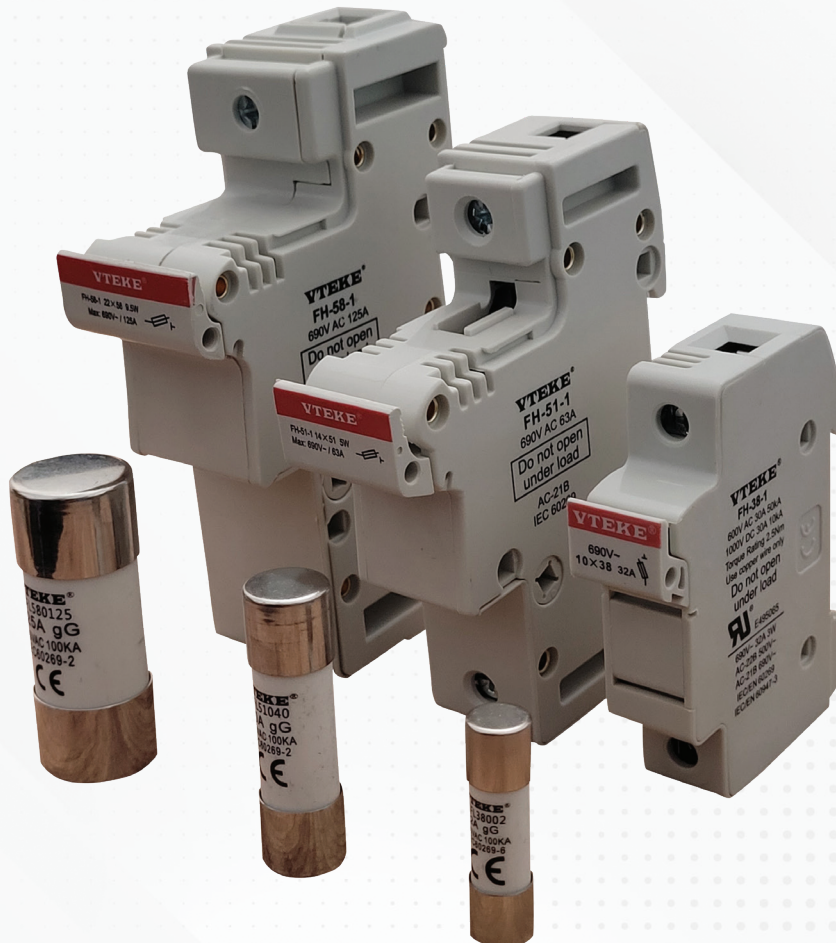

ANALOG ÖLÇÜ ALETLERİ

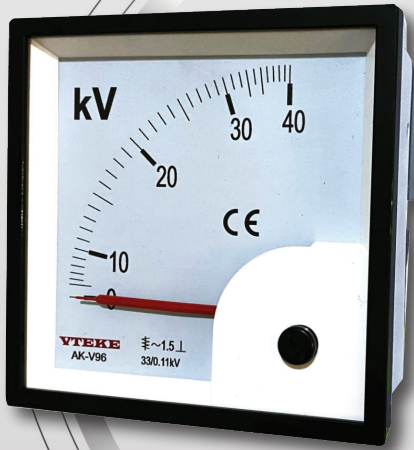

VTEKE®

FİYAT LİSTESİ
VOLTMETRELER

VOLTMETRELER		
AK-V72-500V	ANALOG VOLTMETRE 72 X 72 500V	\$17,64
AK-V96-500V	ANALOG VOLTMETRE 96 X 96 500V	\$18,90
AK-V72-XX/0.1	OG ANALOG VOLTMETRE 72 X 72 (XX kV/100V)	\$21,06
AK-V72-XX/0.11	OG ANALOG VOLTMETRE 72 X 72 (XX kV/110V)	\$21,06
AK-V72-XX/0.22	OG ANALOG VOLTMETRE 72 X 72 (XX kV/220V)	\$21,06
AK-V96-XX/0.1	OG ANALOG VOLTMETRE 96 X 96 (XX kV/100V)	\$22,68
AK-V96-XX/0.11	OG ANALOG VOLTMETRE 96 X 96 (XX kV/110V)	\$22,68
AK-V96-XX/0.22	OG ANALOG VOLTMETRE 96 X 96 (XX kV/220V)	\$22,68

FİYAT LİSTESİ
AMPERMETRELER

AMPERMETRELER		
AK-A72-5	ANALOG AMPERMETRE 72 X 72, 5/5A	\$15,96
AK-A72-10	ANALOG AMPERMETRE 72 X 72, 10/5A	\$15,96
AK-A72-15	ANALOG AMPERMETRE 72 X 72, 15/5A	\$15,96
AK-A72-20	ANALOG AMPERMETRE 72 X 72, 20/5A	\$15,96
AK-A72-25	ANALOG AMPERMETRE 72 X 72, 25/5A	\$15,96
AK-A72-30	ANALOG AMPERMETRE 72 X 72, 30/5A	\$15,96
AK-A72-40	ANALOG AMPERMETRE 72 X 72, 40/5A	\$15,96
AK-A72-50	ANALOG AMPERMETRE 72 X 72, 50/5A	\$15,96
AK-A72-60	ANALOG AMPERMETRE 72 X 72, 60/5A	\$15,96
AK-A72-75	ANALOG AMPERMETRE 72 X 72, 75/5A	\$15,96
AK-A72-80	ANALOG AMPERMETRE 72 X 72, 80/5A	\$15,96
AK-A72-100	ANALOG AMPERMETRE 72 X 72, 100/5A	\$15,96
AK-A72-125	ANALOG AMPERMETRE 72 X 72, 125/5A	\$15,96
AK-A72-150	ANALOG AMPERMETRE 72 X 72, 150/5A	\$15,96
AK-A72-160	ANALOG AMPERMETRE 72 X 72, 160/5A	\$15,96
AK-A72-200	ANALOG AMPERMETRE 72 X 72, 200/5A	\$15,96
AK-A72-250	ANALOG AMPERMETRE 72 X 72, 250/5A	\$15,96
AK-A72-300	ANALOG AMPERMETRE 72 X 72, 300/5A	\$15,96
AK-A72-400	ANALOG AMPERMETRE 72 X 72, 400/5A	\$15,96
AK-A72-500	ANALOG AMPERMETRE 72 X 72, 500/5A	\$15,96
AK-A72-600	ANALOG AMPERMETRE 72 X 72, 600/5A	\$15,96
AK-A72-630	ANALOG AMPERMETRE 72 X 72, 630/5A	\$15,96
AK-A72-750	ANALOG AMPERMETRE 72 X 72, 750/5A	\$15,96
AK-A72-800	ANALOG AMPERMETRE 72 X 72, 800/5A	\$15,96



AMPERMETRELER

AK-A72-1000	ANALOG AMPERMETRE 72 X 72, 1000/5A	\$15,96
AK-A72-1200	ANALOG AMPERMETRE 72 X 72, 1200/5A	\$15,96
AK-A72-1250	ANALOG AMPERMETRE 72 X 72, 1250/5A	\$15,96
AK-A72-1500	ANALOG AMPERMETRE 72 X 72, 1500/5A	\$15,96
AK-A72-1600	ANALOG AMPERMETRE 72 X 72, 1600/5A	\$15,96
AK-A72-2000	ANALOG AMPERMETRE 72 X 72, 2000/5A	\$15,96
AK-A72-2500	ANALOG AMPERMETRE 72 X 72, 2500/5A	\$15,96
AK-A72-3000	ANALOG AMPERMETRE 72 X 72, 3000/5A	\$15,96
AK-A72-3200	ANALOG AMPERMETRE 72 X 72, 3200/5A	\$15,96
AK-A72-4000	ANALOG AMPERMETRE 72 X 72, 4000/5A	\$15,96
AK-A72-5000	ANALOG AMPERMETRE 72 X 72, 5000/5A	\$15,96
AK-A72-6000	ANALOG AMPERMETRE 72 X 72, 6000/5A	\$15,96
AK-A72-6300	ANALOG AMPERMETRE 72 X 72, 6300/5A	\$15,96
AK-A96-5	ANALOG AMPERMETRE 96 X 96, 5/5A	\$17,67
AK-A96-10	ANALOG AMPERMETRE 96 X 96, 10/5A	\$17,67
AK-A96-15	ANALOG AMPERMETRE 96 X 96, 15/5A	\$17,67
AK-A96-20	ANALOG AMPERMETRE 96 X 96, 20/5A	\$17,67
AK-A96-25	ANALOG AMPERMETRE 96 X 96, 25/5A	\$17,67
AK-A96-30	ANALOG AMPERMETRE 96 X 96, 30/5A	\$17,67
AK-A96-40	ANALOG AMPERMETRE 96 X 96, 40/5A	\$17,67
AK-A96-50	ANALOG AMPERMETRE 96 X 96, 50/5A	\$17,67
AK-A96-60	ANALOG AMPERMETRE 96 X 96, 60/5A	\$17,67
AK-A96-75	ANALOG AMPERMETRE 96 X 96, 75/5A	\$17,67
AK-A96-80	ANALOG AMPERMETRE 96 X 96, 80/5A	\$17,67
AK-A96-100	ANALOG AMPERMETRE 96 X 96, 100/5A	\$17,67
AK-A96-125	ANALOG AMPERMETRE 96 X 96, 125/5A	\$17,67
AK-A96-150	ANALOG AMPERMETRE 96 X 96, 150/5A	\$17,67
AK-A96-160	ANALOG AMPERMETRE 96 X 96, 160/5A	\$17,67
AK-A96-200	ANALOG AMPERMETRE 96 X 96, 200/5A	\$17,67
AK-A96-250	ANALOG AMPERMETRE 96 X 96, 250/5A	\$17,67
AK-A96-300	ANALOG AMPERMETRE 96 X 96, 300/5A	\$17,67
AK-A96-400	ANALOG AMPERMETRE 96 X 96, 400/5A	\$17,67
AK-A96-500	ANALOG AMPERMETRE 96 X 96, 500/5A	\$17,67
AK-A96-600	ANALOG AMPERMETRE 96 X 96, 600/5A	\$17,67
AK-A96-630	ANALOG AMPERMETRE 96 X 96, 630/5A	\$17,67
AK-A96-750	ANALOG AMPERMETRE 96 X 96, 750/5A	\$17,67
AK-A96-800	ANALOG AMPERMETRE 96 X 96, 800/5A	\$17,67
AK-A96-1000	ANALOG AMPERMETRE 96 X 96, 1000/5A	\$17,67
AK-A96-1200	ANALOG AMPERMETRE 96 X 96, 1200/5A	\$17,67
AK-A96-1250	ANALOG AMPERMETRE 96 X 96, 1250/5A	\$17,67
AK-A96-1500	ANALOG AMPERMETRE 96 X 96, 1500/5A	\$17,67
AK-A96-1600	ANALOG AMPERMETRE 96 X 96, 1600/5A	\$17,67
AK-A96-2000	ANALOG AMPERMETRE 96 X 96, 2000/5A	\$17,67
AK-A96-2500	ANALOG AMPERMETRE 96 X 96, 2500/5A	\$17,67



AMPERMETRELER

AK-A96-3000	ANALOG AMPERMETRE 96 X 96, 3000/5A	\$17,67
AK-A96-3200	ANALOG AMPERMETRE 96 X 96, 3200/5A	\$17,67
AK-A96-4000	ANALOG AMPERMETRE 96 X 96, 4000/5A	\$17,67
AK-A96-5000	ANALOG AMPERMETRE 96 X 96, 5000/5A	\$17,67
AK-A96-6000	ANALOG AMPERMETRE 96 X 96, 6000/5A	\$17,67
AK-A96-6300	ANALOG AMPERMETRE 96 X 96, 6300/5A	\$17,67

FİYAT LİSTESİ
DİREKT AMPERMETRELER
DİREKT AMPERMETRELER

AK-A72-10D	DİREKT AMPERMETRE 72 X 72 10A	\$17,67
AK-A72-15D	DİREKT AMPERMETRE 72 X 72 15A	\$17,67
AK-A72-20D	DİREKT AMPERMETRE 72 X 72 20A	\$17,67
AK-A72-25D	DİREKT AMPERMETRE 72 X 72 25A	\$17,67
AK-A72-30D	DİREKT AMPERMETRE 72 X 72 30A	\$17,67
AK-A72-40D	DİREKT AMPERMETRE 72 X 72 40A	\$17,67
AK-A72-50D	DİREKT AMPERMETRE 72 X 72 50A	\$17,67
AK-A72-60D	DİREKT AMPERMETRE 72 X 72 60A	\$17,67
AK-A72-75D	DİREKT AMPERMETRE 72 X 72 75A	\$17,67
AK-A72-80D	DİREKT AMPERMETRE 72 X 72 80A	\$17,67
AK-A72-100D	DİREKT AMPERMETRE 72 X 72, 100A	\$18,24
AK-A96-10D	DİREKT AMPERMETRE 96 X 96 10A	\$19,95
AK-A96-15D	DİREKT AMPERMETRE 96 X 96 15A	\$19,95
AK-A96-20D	DİREKT AMPERMETRE 96 X 96 20A	\$19,95
AK-A96-25D	DİREKT AMPERMETRE 96 X 96 25A	\$19,95
AK-A96-30D	DİREKT AMPERMETRE 96 X 96 30A	\$19,95
AK-A96-40D	DİREKT AMPERMETRE 96 X 96 40A	\$19,95
AK-A96-50D	DİREKT AMPERMETRE 96 X 96 50A	\$19,95
AK-A96-60D	DİREKT AMPERMETRE 96 X 96 60A	\$19,95
AK-A96-75D	DİREKT AMPERMETRE 96 X 96 75A	\$19,95
AK-A96-80D	DİREKT AMPERMETRE 96 X 96 80A	\$19,95
AK-A96-100D	DİREKT AMPERMETRE 96 X 96, 100A	\$20,52



FİYAT LİSTESİ
FREKANSMETRELER
FREKANSMETRELER

AK-F96	ANALOG FREKANSMETRE 45-55Hz 96X96	\$66,00
AK-F72	ANALOG FREKANSMETRE 45-55Hz 72X72	\$63,00

YENİ

FİYAT LİSTESİ
KOMÜTATÖRLER
KOMÜTATÖRLER

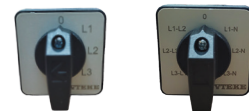
CAV16701	VOLTMETRE KOMÜTATÖRÜ komütatörü (L-L & L-N) + 0, 7 POZ., 16A
CAV16403	AMPERMETRE KOMÜTATÖRÜ 3+0 POZ., 16A



CAM SİGORTALAR



VTEKE®

FİYAT LİSTESİ
CAM SİGORTALAR

CAM SİGORTA 5X20		
VGf-5-0.25	Cam Sigorta 5x20 0.25A	\$0,05
VGf-5-0.5	Cam Sigorta 5x20 0.5A	\$0,05
VGf-5-1	Cam Sigorta 5x20 1A	\$0,05
VGf-5-2	Cam Sigorta 5x20 2A	\$0,05
VGf-5-2.5	Cam Sigorta 5x20 2.5A	\$0,05
VGf-5-3.15	Cam Sigorta 5x20 3.15A	\$0,05
VGf-5-4	Cam Sigorta 5x20 4A	\$0,05
VGf-5-5	Cam Sigorta 5x20 5A	\$0,05
VGf-5-6	Cam Sigorta 5x20 6A	\$0,05
VGf-5-8	Cam Sigorta 5x20 8A	\$0,05
VGf-5-10	Cam Sigorta 5x20 10A	\$0,05
VGf-5-15	Cam Sigorta 5x20 15A	\$0,05
VGf-5-20	Cam Sigorta 5x20 20A	\$0,05
VGf-5-25	Cam Sigorta 5x20 25A	\$0,05
VGf-5-30	Cam Sigorta 5x20 30A	\$0,05



CAM SİGORTA 6X30		
VGf-6-1	Cam Sigorta 6x30 1A	\$0,06
VGf-6-2	Cam Sigorta 6x30 2A	\$0,06
VGf-6-3	Cam Sigorta 6x30 3A	\$0,06
VGf-6-5	Cam Sigorta 6x30 5A	\$0,06
VGf-6-8	Cam Sigorta 6x30 8A	\$0,06
VGf-6-10	Cam Sigorta 6x30 10A	\$0,06
VGf-6-15	Cam Sigorta 6x30 15A	\$0,06
VGf-6-20	Cam Sigorta 6x30 20A	\$0,06
VGf-6-30	Cam Sigorta 6x30 30A	\$0,06



CAM SİGORTA YUVALARI		
GFH-5	Cam Sigorta Yuvası - Pano Tipi 5x20	\$1,52
GFH-6	Cam Sigorta Yuvası - Pano Tipi 6x30	\$2,17
GFHC-5	Cam Sigorta Yuvası - Kablolu 5x20	\$0,65
GFHC-6	Cam Sigorta Yuvası - Kablolu 6x30	\$0,76



AKIM TRANSDÜSERİ

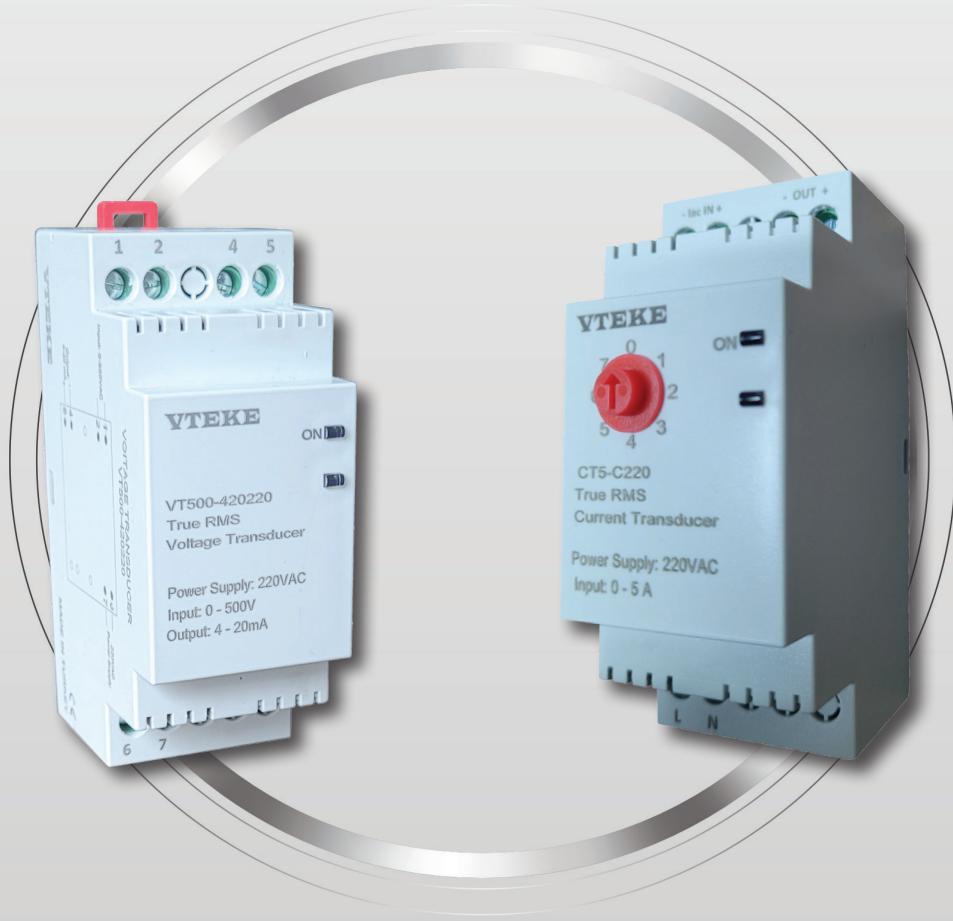

VTEKE®

TEK FAZ TRANSDÜSER

Kod : CT1-420220

XX XXX-XXX XXX

Transdüser Tipi	Giriş	Çıkış	Besleme Voltajı
CT (Akım Transdüseri)	• 1 (0-1AAC)	• M (Seçilebilir)	• 24 (9-34VDC)
VT (Gerilim Transdüseri)	• 5 (0-5AAC)	• 420 (4-20mA)	• 220 (85-280VAC)
	• 500 (0-500VAC)	• 020 (0-20mA)	
	• 24 (0-24VAC)	• 005 (0-5V)	
	• İsteğe Göre	• 010 (1-5V)	
		• 015 (1-5V)	
		• 210 (2-10V)	

YENİ

FİYAT LİSTESİ

AKIM TRANSDÜSER

AKIM TRANSDÜSERİ (GİRİŞ 0-5A)		
CT-5-M1-24	AKIM TRANSDÜSERİ, GİRİŞ:5A, ÇOKLU ÇIKIŞ, UN: 24V	\$71,66
CT-5-M1-220	AKIM TRANSDÜSERİ, GİRİŞ:5A, ÇOKLU ÇIKIŞ, UN:220V	\$80,34
CT-5-42024	AKIM TRANSDÜSERİ, GİRİŞ:5A, ÇIKIŞ: 4-20MA, UN: 24V	\$57,54
CT-5-02024	AKIM TRANSDÜSERİ, GİRİŞ:5A, ÇIKIŞ: 0-20MA, UN: 24V	\$57,54
CT-5-00524	AKIM TRANSDÜSERİ, GİRİŞ:5A, ÇIKIŞ: 0-5V, UN: 24V	\$57,54
CT-5-01024	CUAKIM TRANSDÜSERİ, GİRİŞ:5A, ÇIKIŞ: 0-10V, UN: 24V	\$57,54
CT-5-01524	AKIM TRANSDÜSERİ, GİRİŞ:5A, ÇIKIŞ: 1-5V, UN: 24V	\$57,54
CT-5-21024	AKIM TRANSDÜSERİ, GİRİŞ:5A, ÇIKIŞ: 2-10V, UN: 24V	\$57,54
CT-5-420220	AKIM TRANSDÜSERİ, GİRİŞ:5A, ÇIKIŞ: 4-20MA, UN: 220V	\$66,23
CT-5-020220	AKIM TRANSDÜSERİ, GİRİŞ:5A, ÇIKIŞ: 0-20MA, UN: 220V	\$66,23
CT-5-005220	AKIM TRANSDÜSERİ, GİRİŞ:5A, ÇIKIŞ: 0-5V, UN: 220V	\$66,23
CT-5-010220	AKIM TRANSDÜSERİ, GİRİŞ:5A, ÇIKIŞ: 0-10V, UN: 220V	\$66,23
CT-5-015220	AKIM TRANSDÜSERİ, GİRİŞ:5A, ÇIKIŞ: 1-5V, UN: 220V	\$66,23
CT-5-210220	AKIM TRANSDÜSERİ, GİRİŞ:5A, ÇIKIŞ: 2-10V, UN: 220V	\$66,23
AKIM TRANSDÜSERİ (GİRİŞ 0-1A)		
CT-1-M1-24	AKIM TRANSDÜSERİ, GİRİŞ:1A, MULTİOUTPUT, UN: 24V	\$71,66
CT-1-M1-220	AKIM TRANSDÜSERİ, GİRİŞ:1A, MULTİOUTPUT, UN:220V	\$80,34
CT-1-42024	AKIM TRANSDÜSERİ, GİRİŞ:1A, ÇIKIŞ: 4-20MA, UN: 24V	\$57,54
CT-1-02024	AKIM TRANSDÜSERİ, GİRİŞ:1A, ÇIKIŞ: 0-20MA, UN: 24V	\$57,54
CT-1-00524	AKIM TRANSDÜSERİ, GİRİŞ:1A, ÇIKIŞ: 0-5V, UN: 24V	\$57,54
CT-1-01024	AKIM TRANSDÜSERİ, GİRİŞ:1A, ÇIKIŞ: 0-10V, UN: 24V	\$57,54
CT-1-01524	AKIM TRANSDÜSERİ, GİRİŞ:1A, ÇIKIŞ: 1-5V, UN: 24V	\$57,54
CT-1-21024	AKIM TRANSDÜSERİ, GİRİŞ:1A, ÇIKIŞ: 2-10V, UN: 24V	\$57,54
CT-1-420220	AKIM TRANSDÜSERİ, GİRİŞ:1A, ÇIKIŞ: 4-20MA, UN: 220V	\$66,23
CT-1-020220	AKIM TRANSDÜSERİ, GİRİŞ:1A, ÇIKIŞ: 0-20MA, UN: 220V	\$66,23
CT-1-005220	AKIM TRANSDÜSERİ, GİRİŞ:1A, ÇIKIŞ: 0-5V, UN: 220V	\$66,23
CT-1-010220	AKIM TRANSDÜSERİ, GİRİŞ:1A, ÇIKIŞ: 0-10V, UN: 220V	\$66,23
CT-1-015220	AKIM TRANSDÜSERİ, GİRİŞ:1A, ÇIKIŞ: 1-5V, UN: 220V	\$66,23
CT-1-210220	AKIM TRANSDÜSERİ, GİRİŞ:1A, ÇIKIŞ: 2-10V, UN: 220V	\$66,23



AKÜ ŞARJ ALETİ VE GÜÇ KAYNAKLARI

FİYAT LİSTESİ

AKÜ ŞARJ ALETİ

AKÜ ŞARJ ALETİ		
VBC-05A	AKÜ ŞARJ ALETİ 12/24V 5A 70W	\$74,37
VBC-1205	AKÜ ŞARJ ALETİ 12V 5A 70W	\$62,97
VBC-1210	AKÜ ŞARJ ALETİ 12V 10A 140W	\$67,31
VBC-2405	AKÜ ŞARJ ALETİ 24V 5A 140W	\$65,14
VBC-2410	AKÜ ŞARJ ALETİ 24V 10A 275W	\$141,14
VBC-3002	AKÜ ŞARJ ALETİ 30V 2.2A 70W	\$65,72
VBC-1205D	AKÜ ŞARJ ALETİ 12V 5A 70W, RAYA MONTAJ	\$65,83
VBC-1210D	AKÜ ŞARJ ALETİ 12V 10A 140W , RAYA MONTAJ	\$70,17
VBC-2405D	AKÜ ŞARJ ALETİ 24V 5A 140W, RAYA MONTAJ	\$68,00
VBC-2410D	AKÜ ŞARJ ALETİ 24V 10A 275W, RAYA MONTAJ	\$144,00
VBC-3002D	AKÜ ŞARJ ALETİ 30V 2.2A 70W , RAYA MONTAJ	\$68,58



FİYAT LİSTESİ

GÜÇ KAYNAKLARI

GÜÇ KAYNAKLARI		
PSU-2403	GÜÇ KAYNAĞI - RAY TİPİ 24V 3A	\$51,50
PSU-2406	GÜÇ KAYNAĞI - RAY TİPİ 24V 6A	\$77,00



VTEKE®

DİJİTAL ÖLÇÜ ALETLERİ

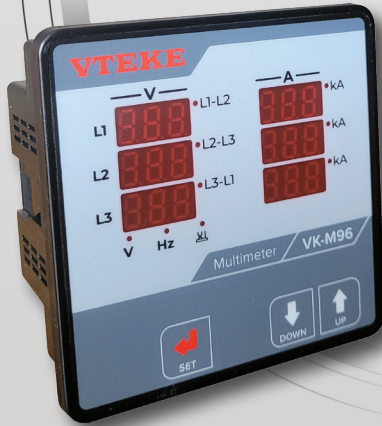

VTEKE®



FIYAT LİSTESİ
ŞEBEKE ANALİZÖRLERİ VE MULTİMETRELER

ŞEBEKE ANALİZÖRLERİ VE MULTİMETRELER			
EA-C1	Şebeke Analizörleri (2-31.Harmonik Ölçümü,RS-485 Haberleşmeli)	\$98,57	
EA-C4	Şebeke Analizörleri (2-31.Harmonik Ölçümü,RS-485 Haberleşmeli,Custom LCD)	\$157,71	
EA-C5	Şebeke Analizörleri (2-55.Harmonik Ölç,RS-485 Hab,2 Röle çıkışı,1 Dij. İntput,Custom LCD)	\$226,83	
VK-M96-C	LCD Ekran,Setli ve Haberleşmeli Multimetre (A,V,F,kW,kWh)	\$106,45	
VK-M96	Multimetre 96x96 mm, (A,V,F, faz sıralı)	\$53,23	
VK-M72	Multimetre 72X72 mm, (A,V,F, faz sıralı)	\$53,23	
VK-M-250D	Direkt Multimetre 96x96 mm, (A,V,F, faz sıralı)	\$76,22	
VK-M-DIN	Multimetre, W-otomat tipi	\$61,11	

FİYAT LİSTESİ
DİJİTAL AMPERMETRELER

DİJİTAL AMPERMETRELER			
VK-A72	Dijital Ampermetre 72X72	\$31,03	
VK-A96	Dijital Ampermetre 96X96	\$31,03	
VK-A96-T	3-FAZ , Dijital Ampermetre 96X96	\$50,27	
DC-A72	Dijital DC Ampermetre 72X72	\$62,37	
VK-A72S	Setli Dijital Ampermetre 72x72mm (150mA-995A)	\$50,00	

FİYAT LİSTESİ
DİJİTAL FREKANSMETRELER

DİJİTAL FREKANSMETRELER			
VK-F72	Dijital Frekansmetre 72x72mm (1- 400Hz) (15V - 500V AC)	\$31,54	
VK-F96	Dijital Frekansmetre 96x96mm (1- 400Hz) (15V - 500V AC)	\$31,54	

FİYAT LİSTESİ**DIJİTAL VOLTMETRELER**

DİJİTAL VOLTMETRELER			
VK-V72	Dijital Voltmetre 72X72	\$27,60	
VK-V96	Dijital Voltmetre 96X96	\$27,60	
VK-V72S	3 Fazlı Voltmetre 72X72 Seçmeli	\$37,82	
VK-V96S	3 Fazlı Voltmetre 96X96 Seçmeli	\$37,82	
VK-V96-T2	Dijital 3 Faz Voltmetre 96x96mm (1-500V AC)	\$53,19	
DC-V72	Dijital DC Voltmetre 72X72	\$52,68	

ZAMAN RÖLELERİ

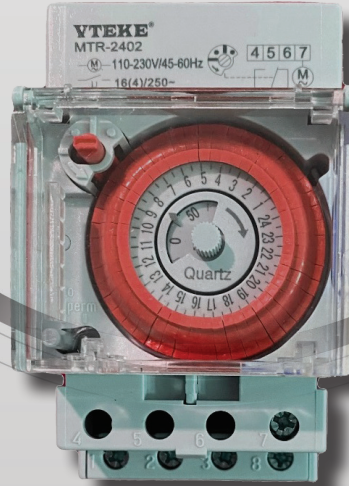
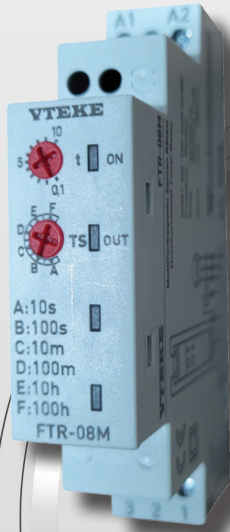





VTEKE®

FİYAT LİSTESİ**ZAMAN RÖLELERİ**

ZAMAN RÖLELERİ			
MTR-2401	OTOMAT TİPİ MEKANİK ZAMAN SAATİ, 24SAAT, PİL100SAAT, MİN. 15DK	\$27,14	
MTR-2402	OTOMAT TİPİ MEKANİK ZAMAN SAATİ, 24SAAT, PİL150SAAT, MİN. 30DK	\$30,00	
MTR-2403D	OTOMAT TİPİ DİJİTAL ZAMAN SAATİ, 24SAAT	\$36,91	
DTR-30	0.1sn-30sn Zaman Rölesi	\$15,49	
DTR-60	0.1sn-60sn Zaman Rölesi	\$14,86	
DTR-60D	0.1sn-60sn Zaman Rölesi Bırakmada gecikmeli	\$14,86	
DTR-03M	0.1sn-3DK Zaman Rölesi	\$15,78	

FİYAT LİSTESİ
ZAMAN RÖLELERİ

ZAMAN RÖLELERİ			
FTR-08	0.1sn-100 Saat Multifonksiyonlu Zaman Rölesi, 220VAC / 24VDC	\$19,31	
FTR-08D	0.1sn-100 Saat Multifonksiyonlu Zaman Rölesi, Bırakmada gecikmeli, 220VAC / 24VDC	\$19,31	
FTR-08M	0.1sn-100 Saat Multifonksiyonlu Zaman Rölesi(12-240V AC/DC)	\$24,45	
FTR-10	Multifonksiyonlu Multi Timer (12-240V AC/DC) 10program	\$28,58	
FTR-09	Multifonksiyonlu Flaşör Rölesi	\$22,87	
FTR-07	Multifonksiyonlu Sağ-Sol Rölesi	\$23,66	
FTR-10D	Zaman Rölesi çekmede - bırakmada gecikmeli 99dk	\$31,43	

KUMANDA RÖLELERİ

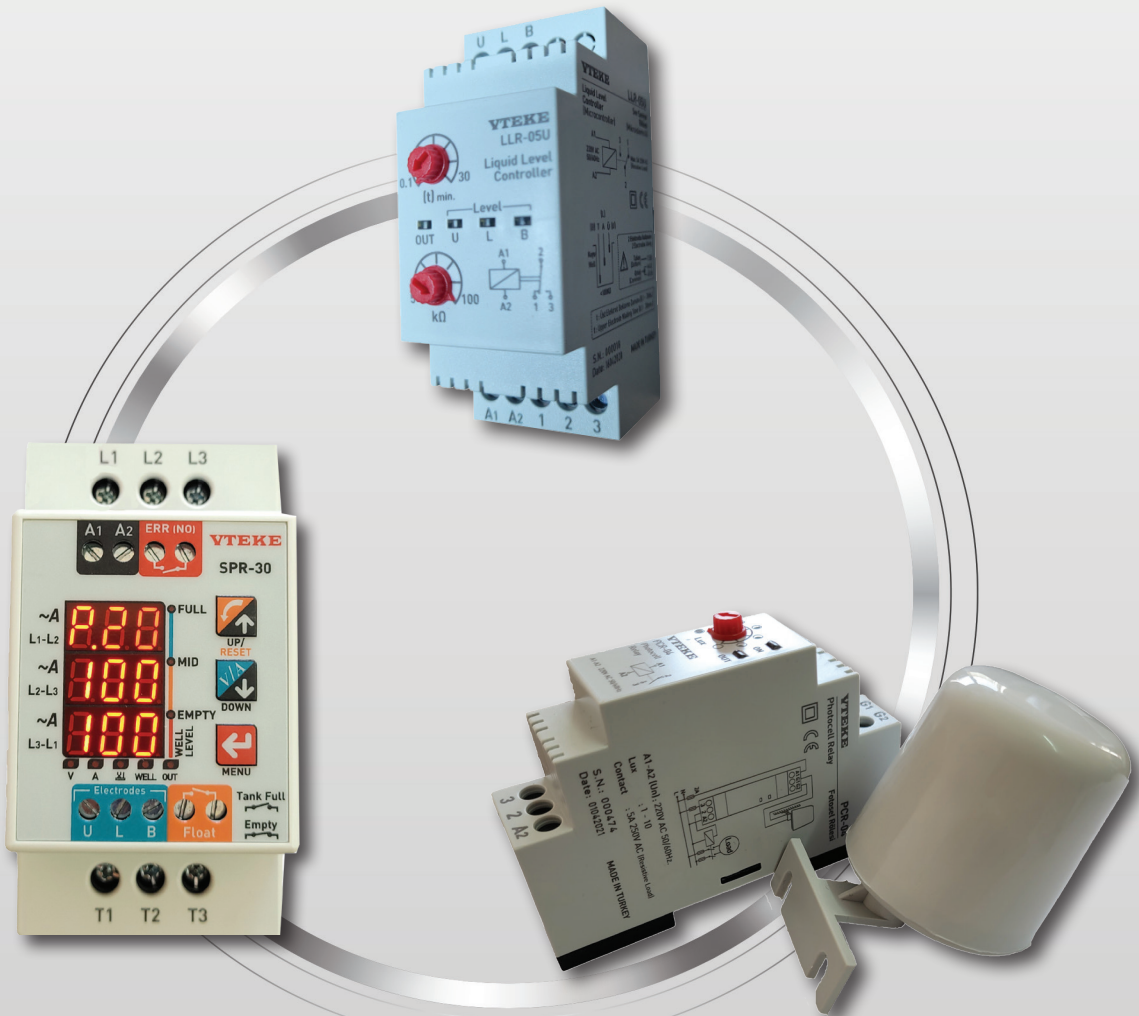

VTEKE®

FİYAT LİSTESİ
KUMANDA RÖLELERİ

KUMANDA RÖLELERİ			
DTR-SD	Yıldız-Üçgen Rölesi	\$21,65	
DTR-SS	Start-Stop rölesi	\$21,68	
PCR-04	Fotosel Rölesi, Lux Ayarlı	\$17,31	
PCR-03	Fotosel Rölesi, 10 Lux Sabit	\$14,92	
HPM-02	Hidrofor Sıralama Rölesi (3 kontaklı)	\$27,64	
HPM-03	Hidrofor Sıralama Rölesi (2 kontaklı)	\$30,04	
SPR-30	Dijital Kontaktörlü Trifaze Dalgıç Kontrol Rölesi (5.5kW'a kadar Direkt Çalışma) (150-270 V AC)	\$85,72	
LLR-05	Hassasiyet Ayarlı Sıvı Seviye Rölesi	\$19,72	
LLR-05U	Hassasiyet Ayarlı ÜST ELEKTROD BEKLEME ZAMANLI Sıvı Seviye Rölesi	\$27,60	
LLE-10	Sıvı Seviye Elektrodu	\$4,29	

KORUMA RÖLELERİ



VTEKE®

FİYAT LİSTESİ
KORUMA RÖLELERİ

KORUMA RÖLELERİ			
DOR-25	0,1-25 A ARASI AYARLI,DİREKT BAĞLANTI ,DİJİTAL TERMİK RÖLESİ	\$53,59	
DOR-50	15-50A A ARASI AYARLI,DİREKT BAĞLANTI ,DİJİTAL TERMİK RÖLESİ	\$60,15	
DOR-100	40-100A ARASI AYARLI,AKIM TRAFOSU (K-L) BAĞLANTILI , DİJİTAL TERMİK RÖLESİ	\$69,75	
DOR-200	90-200A ARASI AYARLI,AKIM TRAFOSU (K-L) BAĞLANTILI , DİJİTAL TERMİK RÖLESİ	\$89,31	
DOR-400	290-400A ARASI AYARLI,AKIM TRAFOSU (K-L) BAĞLANTILI ,DİJİTAL TERMİK RÖLESİ	\$113,14	
PPR-14	NÖTRLÜ Faz Sıralı Faz Koruma Rölesi,	\$21,65	
PPR-24F	NÖTRSÜZ Faz Sıralı Faz Koruma Rölesi, Aşırı-Düşük Gerilim koruma, Faz sarlı	\$25,35	
PPR-05F	Faz Sıralı, Asimetri Ayarlı Faz Koruma Rölesi %5-%25, Aşırı-Düşük Gerilim koruma (3faz+nötr)	\$25,63	
PPR-06F	Faz Sıralı, Asimetri Ayarlı Faz Koruma Rölesi %5-%25, Aşırı-Düşük Gerilim koruma (3faz-nötrsüz)	\$25,63	
VCR-11	Monofaze Aşırı-Düşük Gerilim Koruma Rölesi	\$26,02	

FİYAT LİSTESİ
KORUMA RÖLELERİ

KORUMA RÖLELERİ			
VCR-02F	Aşırı-Düşük Ayarlı Faz Sıralı Trifaze Gerilim Kontrol Rölesi-Monofaz Kadran (3faz+nötr)	\$26,02	
VCR-03F	Aşırı-Düşük Ayarlı Faz Sıralı Trifaze Gerilim Kontrol Rölesi-Trifaze Kadran (3faz-Nötrsüz)	\$26,02	
VCR-12F	Aşırı-Düşük Ayarlı Faz Sıralı Trifaze Gerilim Kontrol Rölesi-Monofaz Kadran (3faz+nötr)	\$26,02	
DVC-04	Trifaze Dijital Aşırı -Düşük Gerilim Kontrol Rölesi	\$46,64	
DVC-01	Monofaze Dijital Aşırı-Düşük Gerilim Kontrol Röles	\$41,88	
CON-12	Digital Kontaktör Termik (4 kW'a kadar), 12A	\$55,95	
CON-18	Digital Kontaktör Termik (7,5 kW'a kadar), 18A	\$67,15	
CON-25	Digital Kontaktör Termik (11 kW'a kadar), 25A	\$71,60	
CON-50	Digital Kontaktör Termik (22 kW'a kadar), 50A	\$152,15	
VUC-01D	Düşük Akım Kontrol Rölesi	\$40,42	

BUTON SERİSİ VE AKSESUARLARI



VTEKE®

FİYAT LİSTESİ
Ø 22 MM BUTON SERİSİ

PPB BUTON SERİSİ			
PPB-RG-12	22MM ON-OFF (YEŞİL-KIRMIZI) BUTON (NA+NK)	\$3,37	
PPB-EM-02	22MM KALICI MANTAR ACIL BUTON, 40MM	\$2,55	
PPB-SE-01	22MM KALICI SEÇİCİ MANDAL BUTON 1-0	\$2,19	
PPB-SE-11	22MM KALICI SEÇİCİ MANDAL BUTON 1-0-11	\$2,87	
PPB-SP-01-G	22MM YAYLI BUTON YEŞİL, NA	\$1,86	
PPB-SP-01-R	22MM YAYLI BUTON KIRMIZI, NK	\$1,86	
PPB-SP-01-B	22MM YAYLI BUTON MAVİ, NA	\$1,86	
PPB-SP-01-BK	22MM YAYLI BUTON SİYAH, NA	\$1,86	
PPB-SP-01-Y	22MM YAYLI BUTON SARI, NA	\$1,86	
PPB-CO-1	1 NA KONTAKT	\$0,85	
PPB-CO-2	1 NK KONTAKT	\$0,85	

FİYAT LİSTESİ
METAL BUTON SERİSİ

METAL BUTON SERİSİ			
MPB-RG-12	VİDA MONTAJLI, METAL SERİSİ 22MM ON-OFF (YEŞİL-KIRMIZI) BUTON (NA+NK) -	\$5,09	
MPB-EM-02	VİDA MONTAJLI, METAL SERİSİ 22MM KALICI MANTAR ACIL BUTON, 40MM	\$3,88	
MPB-SE-01	VİDA MONTAJLI, METAL SERİSİ 22MM KALICI SEÇİCİ MANDAL BUTON 1-0	\$3,09	
MPB-SE-11	VİDA MONTAJLI, METAL SERİSİ 22MM KALICI SEÇİCİ MANDAL BUTON 1-0-11	\$3,98	
MPB-SP-01-G	VİDA MONTAJLI, METAL SERİSİ 22MM YAYLI BUTON YEŞİL, NA	\$2,66	
MPB-SP-01-R	VİDA MONTAJLI, METAL SERİSİ 22MM YAYLI BUTON KIRMIZI, NK	\$2,66	
MPB-SP-01-B	VİDA MONTAJLI, METAL SERİSİ 22MM YAYLI BUTON MAVİ, NA	\$2,66	
MPB-SP-01-BK	VİDA MONTAJLI, METAL SERİSİ 22MM YAYLI BUTON SİYAH, NA	\$2,66	
MPB-SP-01-Y	VİDA MONTAJLI, METAL SERİSİ 22MM YAYLI BUTON SARI, NA	\$2,66	

FİYAT LİSTESİ**BUTON AKSESUARLARI**

BUTON AKSESUARLARI			
PPA-101	BUTON KORUMA KUTUSU - ŞEFFAF KAPAK	\$1,88	
PPA-102	BUTON ÜST KORUMA -SARI	\$2,19	
PPA-103	BUTON 4LUK KORUMA -SARI	\$1,52	
PPA-105	ŞEFFAF SU GEÇİRMEZ KAPAK	\$0,34	
PPA-104	ACIL STOP ETİKETİ - SARI	\$0,40	
MA-22-1	22MM Plastik Buton Rozeti	\$0,13	



FİYAT LİSTESİ
Ø 22 MM SİNYAL LAMBALARI
Ø22 MM SİNYAL LAMBALARI

SIL-22-220-G	LEDLİ SİNYAL LAMP 22MM 220VAC YEŞİL	\$1,30
SIL-22-220-R	LEDLİ SİNYAL LAMP 22MM 220VAC KIRMIIZ	\$1,30
SIL-22-220-Y	LEDLİ SİNYAL LAMP 22MM 220VAC SARI	\$1,30
SIL-22-220-W	LEDLİ SİNYAL LAMP 22MM 220VAC BEYAZ	\$1,30
SIL-22-220-A	LEDLİ SİNYAL LAMP 22MM 220VAC TURUNCU	\$1,30
SIL-22-220-B	LEDLİ SİNYAL LAMP 22MM 220VAC MAVİ	\$1,30
SIL-22-24-G	LEDLİ SİNYAL LAMP 22MM 24VDC YEŞİL	\$1,30
SIL-22-24-R	LEDLİ SİNYAL LAMP 22MM 24VDC KIRMIIZ	\$1,30
SIL-22-24-Y	LEDLİ SİNYAL LAMP 22MM 24VDC SARI	\$1,30
SIL-22-24-W	LEDLİ SİNYAL LAMP 22MM 24VDC BEYAZ	\$1,30
SIL-22-24-A	LEDLİ SİNYAL LAMP 22MM 24VDC TURUNCU	\$1,30
SIL-22-24-B	LEDLİ SİNYAL LAMP 22MM 24VDC MAVİ	\$1,30
SIL-22-110-G	LEDLİ SİNYAL LAMP 22MM 110VAC YEŞİL	\$1,30
SIL-22-110-R	LEDLİ SİNYAL LAMP 22MM 110VAC KIRMIIZ	\$1,30
SIL-22-110-Y	LEDLİ SİNYAL LAMP 22MM 110VAC SARI	\$1,30
SIL-22-110-W	LEDLİ SİNYAL LAMP 22MM 110VAC BEYAZ	\$1,30
SIL-22-110-A	LEDLİ SİNYAL LAMP 22MM 110VAC TURUNCU	\$1,30
SIL-22-110-B	LEDLİ SİNYAL LAMP 22MM 110VAC MAVİ	\$1,30

FİYAT LİSTESİ
VOLTMETRELER
VOLTMETRELER

VIL-22-G	22MM VOLTMETRE (LEDLİ SİNYAL) YEŞİL	\$3,22
VIL-22-R	22MM VOLTMETRE (LEDLİ SİNYAL) KIRMIIZ	\$3,22
VIL-22-A	22MM VOLTMETRE (LEDLİ SİNYAL) SARI	\$3,22
VIL-22-B	22MM VOLTMETRE (LEDLİ SİNYAL) MAVİ	\$3,37
VIL-22-W	22MM VOLTMETRE (LEDLİ SİNYAL) BEYAZ	\$3,37

FİYAT LİSTESİ
VOLTMETRE + AMPERMETRELER
VOLTMETRE + AMPERMETRE

AIL-22-G	22MM AMPERMETRE+VOLTMETRE (LEDLİ SİNYAL) BEYAZ	\$8,40
AIL-22-R	22MM AMPERMETRE+VOLTMETRE (LEDLİ SİNYAL) BEYAZ	\$8,40
AIL-22-A	22MM AMPERMETRE+VOLTMETRE (LEDLİ SİNYAL) BEYAZ	\$8,40
AIL-22-B	22MM AMPERMETRE+VOLTMETRE (LEDLİ SİNYAL) BEYAZ	\$8,74
AIL-22-W	22MM AMPERMETRE+VOLTMETRE (LEDLİ SİNYAL) BEYAZ	\$8,74



FİYAT LİSTESİ**BUZZERLAR**

BUZZERLAR			
BIL-22-220-R	22MM LEDLİ SİREN 220V KIRMIZI	\$3,54	
BIL-22-24-R	22MM LEDLİ SİREN 24V AC/DC KIRMIZI	\$3,54	

FİYAT LİSTESİ**VİNÇ KUMANDALARI**

VİNÇ KUMANDALARI			
VCC-2-1	ACİL STOPLU VİNÇ KUMANDA 2+1 TEK HIZ	\$20,09	
VCC-4-1	ACİL STOPLU VİNÇ KUMANDA 2+1 TEK HIZ	\$27,14	
VCC-6-1	ACİL STOPLU VİNÇ KUMANDA 6+1 TEK HIZ	\$36,70	
VCC-8-1	ACİL STOPLU VİNÇ KUMANDA 8+1 TEK HIZ	\$44,51	
VCC-2-2	ACİL STOPLU VİNÇ KUMANDA 2+1 ÇİFT HIZ	\$30,40	
VCC-4-2	ACİL STOPLU VİNÇ KUMANDA 4+1 ÇİFT HIZ	\$48,31	
VCC-6-2	ACİL STOPLU VİNÇ KUMANDA 6+1 ÇİFT HIZ	\$65,14	
VCC-8-2	ACİL STOPLU VİNÇ KUMANDA 8+1 ÇİFT HIZ	\$104,88	

FİYAT LİSTESİ**POTANSİYOMETRE**

POTANSİYOMETRE			
PM-05	22MM POTANSİYOMETRE, 5KOHM	\$7,06	
PM-10	22MM POTANSİYOMETRE, 10KOHM	\$7,06	

İŞ -GÜÇ ZAMAN SAATLERİ

FİYAT LİSTESİ

ZAMAN SAATLERİ

ZAMAN SAATLERİ		
HM1-220-AC	MEKANİK İŞ GÜÇ ZAMAN SAATİ 220VAC	\$14,79
HM1-24-AC	MEKANİK İŞ GÜÇ ZAMAN SAATİ 24VAC	\$14,79
HM1-110-AC	MEKANİK İŞ GÜÇ ZAMAN SAATİ 110VAC	\$14,79
HM1-48-AC	MEKANİK İŞ GÜÇ ZAMAN SAATİ 48VAC	\$14,79
HM1-24-DC	MEKANİK İŞ GÜÇ ZAMAN SAATİ 24VDC	\$20,85
OCM-220-AC	MEKANİK DARBE SAYICI 220V	\$18,83



DİJİTAL İŞ GÜÇ ZAMAN SAATİ

YAKINDA...

SERTİFİKALAR



TESLAB Elektrik Laboratuvarları Tic. Ltd. Şti.
Kuzulda Mah. Ankara Cad. No: 34
Aksaray / SAKARYA / TÜRKİYE
Tel: +90 264 437 97 70 Faks: +90 264 437 97 80

DENEY RAPORU
TEST REPORT

Müşteri Adı/Adresi: VTEK ELEKTRİK İTH. İHR. SAN. VE TIC. LTD. ŞTİ.
Mehmet Mah. Adıyemir Çk. Sk. No: 6/3 Gaziosmanpaşa / İSTANBUL

Numaralı Adı ve Tarifi: TK125 4000S A Akım Trafosu

Talep Numarası: 1903.27

Rapor Sayfa Sayısı: 10 + 15 sayfa ek

Deneysel Standartlar: TS EN 61868-1:09.10.2013

Deneysel Sonuçlar: OLULUMLU / Ayrıntılı açıklama yapılmıştır.

Mühür: 29.08.2019

Deneysel Sorumlular: Mehmet KALYONCU, Çiğdem EREN

TESLAB Elektrik Laboratuvarları Tic. Ltd. Şti.
Kuzulda Mah. Ankara Cad. No: 34
Aksaray / SAKARYA / TÜRKİYE
Tel: +90 264 437 97 70 Faks: +90 264 437 97 80

DENEY RAPORU
TEST REPORT

Müşteri Adı/Adresi: VTEK ELEKTRİK İTH. İHR. SAN. VE TIC. LTD. ŞTİ.
Mehmet Mah. Adıyemir Çk. Sk. No: 6/3 Gaziosmanpaşa / İSTANBUL

Numaralı Adı ve Tarifi: TK1000 4000S A Akım Trafosu

Talep Numarası: 1903.27

Rapor Sayfa Sayısı: 10 + 15 sayfa ek

Deneysel Standartlar: TS EN 61868-1:09.10.2013

Deneysel Sonuçlar: OLULUMLU / Ayrıntılı açıklama yapılmıştır.

Mühür: 22.08.2019

Deneysel Sorumlular: Mehmet KALYONCU, Çiğdem EREN

TESLAB Elektrik Laboratuvarları Tic. Ltd. Şti.
Kuzulda Mah. Ankara Cad. No: 34
Aksaray / SAKARYA / TÜRKİYE
Tel: +90 264 437 97 70 Faks: +90 264 437 97 80

DENEY RAPORU
TEST REPORT

Müşteri Adı/Adresi: VTEK ELEKTRİK İTH. İHR. SAN. VE TIC. LTD. ŞTİ.
Mehmet Mah. Adıyemir Çk. Sk. No: 6/3 Gaziosmanpaşa / İSTANBUL

Numaralı Adı ve Tarifi: TK80 2000S A Akım Trafosu

Talep Numarası: 1903.27

Rapor Sayfa Sayısı: 10 + 15 sayfa ek

Deneysel Standartlar: TS EN 61868-1:09.10.2013

Deneysel Sonuçlar: OLULUMLU / Ayrıntılı açıklama yapılmıştır.

Mühür: 29.08.2019

Deneysel Sorumlular: Mehmet KALYONCU, Çiğdem EREN

TESLAB Elektrik Laboratuvarları Tic. Ltd. Şti.
Kuzulda Mah. Ankara Cad. No: 34
Aksaray / SAKARYA / TÜRKİYE
Tel: +90 264 437 97 70 Faks: +90 264 437 97 80

DENEY RAPORU
TEST REPORT

Müşteri Adı/Adresi: VTEK ELEKTRİK İTH. İHR. SAN. VE TIC. LTD. ŞTİ.
Mehmet Mah. Adıyemir Çk. Sk. No: 6/3 Gaziosmanpaşa / İSTANBUL

Numaralı Adı ve Tarifi: TK60 1200S A Akım Trafosu

Talep Numarası: 1903.27

Rapor Sayfa Sayısı: 10 + 15 sayfa ek

Deneysel Standartlar: TS EN 61868-1:09.10.2013

Deneysel Sonuçlar: OLULUMLU / Ayrıntılı açıklama yapılmıştır.

Mühür: 22.08.2019

Deneysel Sorumlular: Mehmet KALYONCU, Çiğdem EREN

TESLAB Elektrik Laboratuvarları Tic. Ltd. Şti.
Kuzulda Mah. Ankara Cad. No: 34
Aksaray / SAKARYA / TÜRKİYE
Tel: +90 264 437 97 70 Faks: +90 264 437 97 80

DENEY RAPORU
TEST REPORT

Müşteri Adı/Adresi: VTEK ELEKTRİK İTH. İHR. SAN. VE TIC. LTD. ŞTİ.
Mehmet Mah. Adıyemir Çk. Sk. No: 6/3 Gaziosmanpaşa / İSTANBUL

Numaralı Adı ve Tarifi: TK40 800S A Akım Trafosu

Talep Numarası: 1903.27

Rapor Sayfa Sayısı: 10 + 15 sayfa ek

Deneysel Standartlar: TS EN 61868-1:09.10.2013

Deneysel Sonuçlar: OLULUMLU / Ayrıntılı açıklama yapılmıştır.

Mühür: 06.08.2019

Deneysel Sorumlular: Mehmet KALYONCU, Çiğdem EREN

TESLAB Elektrik Laboratuvarları Tic. Ltd. Şti.
Kuzulda Mah. Ankara Cad. No: 34
Aksaray / SAKARYA / TÜRKİYE
Tel: +90 264 437 97 70 Faks: +90 264 437 97 80

DENEY RAPORU
TEST REPORT

Müşteri Adı/Adresi: VTEK ELEKTRİK İTH. İHR. SAN. VE TIC. LTD. ŞTİ.
Mehmet Mah. Adıyemir Çk. Sk. No: 6/3 Gaziosmanpaşa / İSTANBUL

Numaralı Adı ve Tarifi: TK30 500S A Akım Trafosu

Talep Numarası: 1903.27

Rapor Sayfa Sayısı: 10 + 15 sayfa ek

Deneysel Standartlar: TS EN 61868-1:09.10.2013

Deneysel Sonuçlar: OLULUMLU / Ayrıntılı açıklama yapılmıştır.

Mühür: 06.08.2019

Deneysel Sorumlular: Mehmet KALYONCU, Çiğdem EREN

TESLAB Elektrik Laboratuvarları Tic. Ltd. Şti.
Kuzulda Mah. Ankara Cad. No: 34
Aksaray / SAKARYA / TÜRKİYE
Tel: +90 264 437 97 70 Faks: +90 264 437 97 80

DENEY RAPORU
TEST REPORT

Müşteri Adı/Adresi: VTEK ELEKTRİK İTH. İHR. SAN. VE TIC. LTD. ŞTİ.
Mehmet Mah. Adıyemir Çk. Sk. No: 6/3 Gaziosmanpaşa / İSTANBUL

Numaralı Adı ve Tarifi: TK300 4000 A Akım Trafosu

Talep Numarası: 1903.27

Rapor Sayfa Sayısı: 10 + 15 sayfa ek

Deneysel Standartlar: TS EN 61868-1:09.10.2013

Deneysel Sonuçlar: OLULUMLU / Ayrıntılı açıklama yapılmıştır.

Mühür: 22.08.2019

Deneysel Sorumlular: Mehmet KALYONCU, Çiğdem EREN

TESLAB Elektrik Laboratuvarları Tic. Ltd. Şti.
Kuzulda Mah. Ankara Cad. No: 34
Aksaray / SAKARYA / TÜRKİYE
Tel: +90 264 437 97 70 Faks: +90 264 437 97 80

DENEY RAPORU
TEST REPORT

Müşteri Adı/Adresi: VTEK ELEKTRİK İTH. İHR. SAN. VE TIC. LTD. ŞTİ.
Mehmet Mah. Adıyemir Çk. Sk. No: 6/3 Gaziosmanpaşa / İSTANBUL

Numaralı Adı ve Tarifi: TK20 300S A Akım Trafosu

Talep Numarası: 1903.27

Rapor Sayfa Sayısı: 10 + 15 sayfa ek

Deneysel Standartlar: TS EN 61868-1:09.10.2013

Deneysel Sonuçlar: OLULUMLU / Ayrıntılı açıklama yapılmıştır.

Mühür: 06.08.2019

Deneysel Sorumlular: Mehmet KALYONCU, Çiğdem EREN

TESLAB Elektrik Laboratuvarları Tic. Ltd. Şti.
Kuzulda Mah. Ankara Cad. No: 34
Aksaray / SAKARYA / TÜRKİYE
Tel: +90 264 437 97 70 Faks: +90 264 437 97 80

DENEY RAPORU
TEST REPORT

Müşteri Adı/Adresi: VTEK ELEKTRİK İTH. İHR. SAN. VE TIC. LTD. ŞTİ.
Mehmet Mah. Adıyemir Çk. Sk. No: 6/3 Gaziosmanpaşa / İSTANBUL

Numaralı Adı ve Tarifi: TK2000 500S A Akım Trafosu

Talep Numarası: 1916.14

Rapor Sayfa Sayısı: 10 + 14 sayfa ek

Deneysel Standartlar: TS EN 61868-1:09.10.2013

Deneysel Sonuçlar: OLULUMLU / Ayrıntılı açıklama yapılmıştır.

Mühür: 05.02.2020

Deneysel Sorumlular: Mehmet KALYONCU, Çiğdem EREN

testla Elektrik Laboratuvarları Tic. Ltd. Şti.
Kuzulda Mah. Ankara Cad. No: 34
Aksaray / SAKARYA / TÜRKİYE
Tel: +90 264 437 97 70 Faks: +90 264 437 97 80

DENEY RAPORU
TEST REPORT

Müşteri Adı/Adresi: VTEK ELEKTRİK İTH. İHR. SAN. VE TIC. LTD. ŞTİ.
Mehmet Mah. Adıyemir Çk. Sk. No: 6/3 Gaziosmanpaşa / İSTANBUL

Numaralı Adı ve Tarifi: Akım Transformatörleri

Talep Numarası: 2022.04

Rapor Sayfa Sayısı: 10 + 14 sayfa ek

Deneysel Standartlar: IEC 61868-1:09.10.2013

Deneysel Sonuçlar: OLULUMLU / Ayrıntılı açıklama yapılmıştır.

Mühür: 29.01.2021

Deneysel Sorumlular: Mehmet KALYONCU, Çiğdem EREN

testla Elektrik Laboratuvarları Tic. Ltd. Şti.
Kuzulda Mah. Ankara Cad. No: 34
Aksaray / SAKARYA / TÜRKİYE
Tel: +90 264 437 97 70 Faks: +90 264 437 97 80

DENEY RAPORU
TEST REPORT

Müşteri Adı/Adresi: VTEK ELEKTRİK İTH. İHR. SAN. VE TIC. LTD. ŞTİ.
Mehmet Mah. Adıyemir Çk. Sk. No: 6/3 Gaziosmanpaşa / İSTANBUL

Numaralı Adı ve Tarifi: Akım Transformatörleri

Talep Numarası: 2104.04

Rapor Sayfa Sayısı: 10 + 14 sayfa ek

Deneysel Standartlar: IEC 61868-1:09.10.2013

Deneysel Sonuçlar: OLULUMLU / Ayrıntılı açıklama yapılmıştır.

Mühür: 08.09.2021

Deneysel Sorumlular: Mehmet KALYONCU, Çiğdem EREN

Sertifika Certificate

DSR CERTIFICATION

VTEK ELEKTRİK İTHALAT İHRACAT SANAYİ VE TİCARET LİMLERİ ŞİRKETİ

MEHMET MAH. ADIYEMİR ÇK. SK. NO: 6/3 GAZİOSMANPAŞA / İSTANBUL

ISO 9001:2015

11.06.2021

10.06.2022

10.06.2023

DSR CERTIFICATION, IAF, IAS

YTEKE®

